

# MEHRSHAHR APARTMENT



February 2026

# CONTENTS

DESIGN PROCESS 04

PLANS 26

EXTERIOR VIEWS 35

DESIGN PROCESS



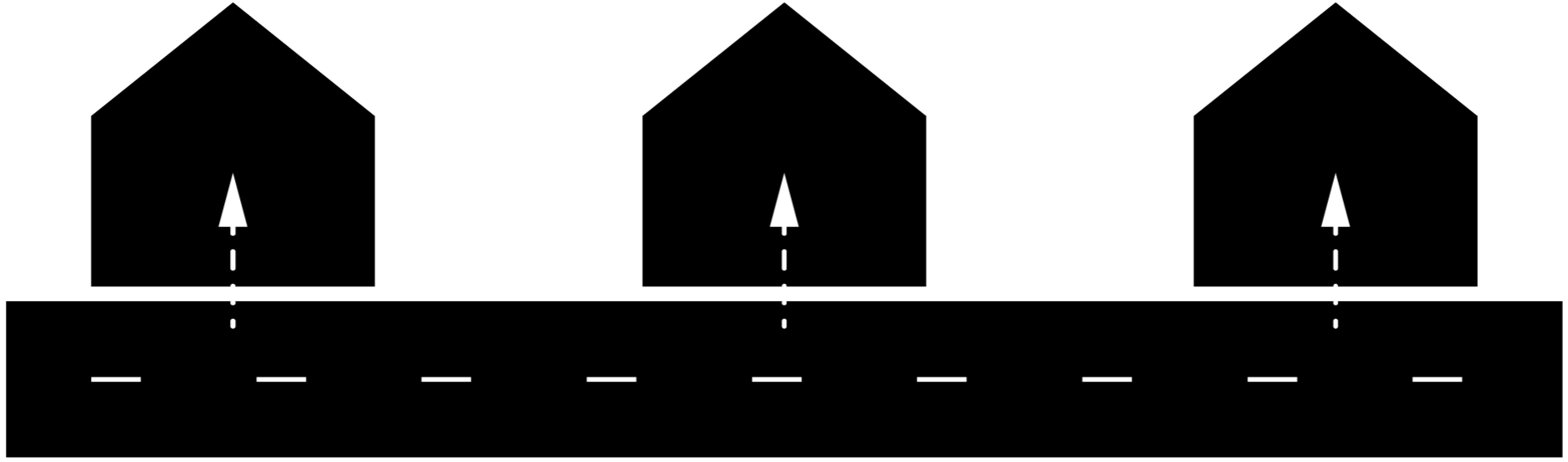

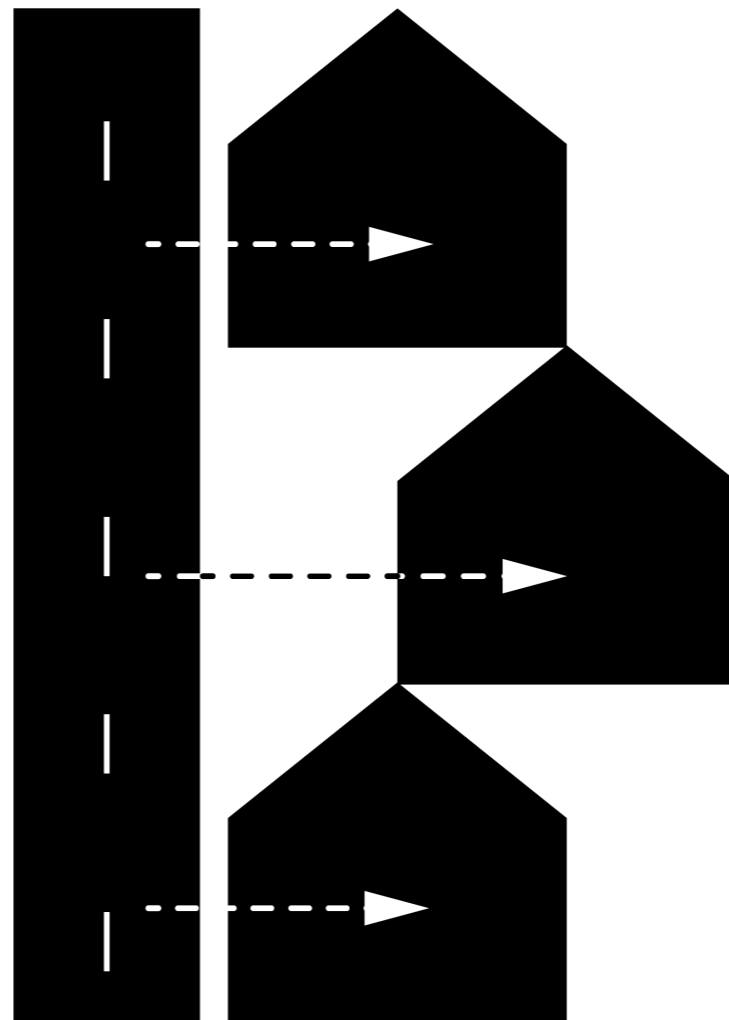

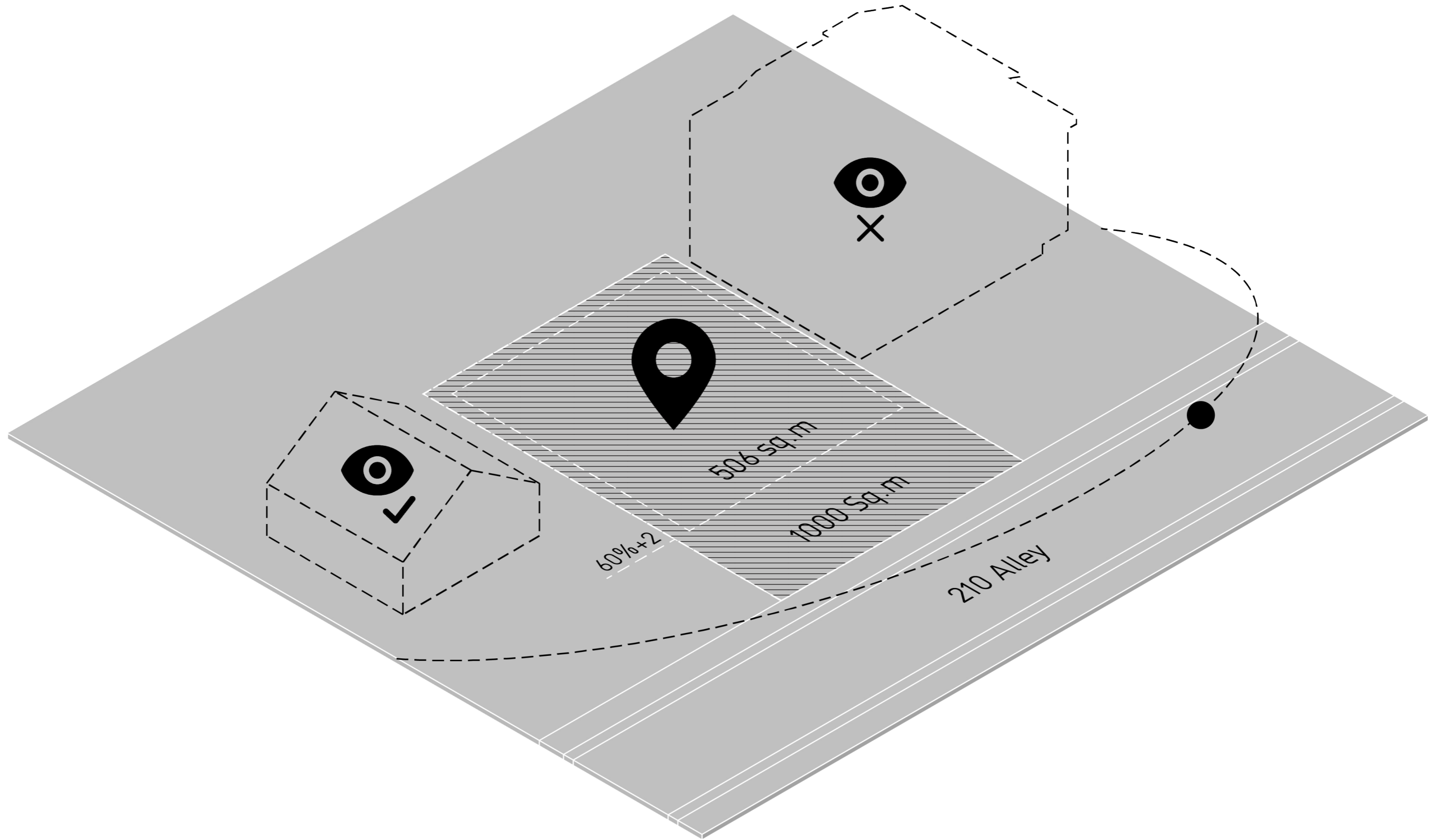

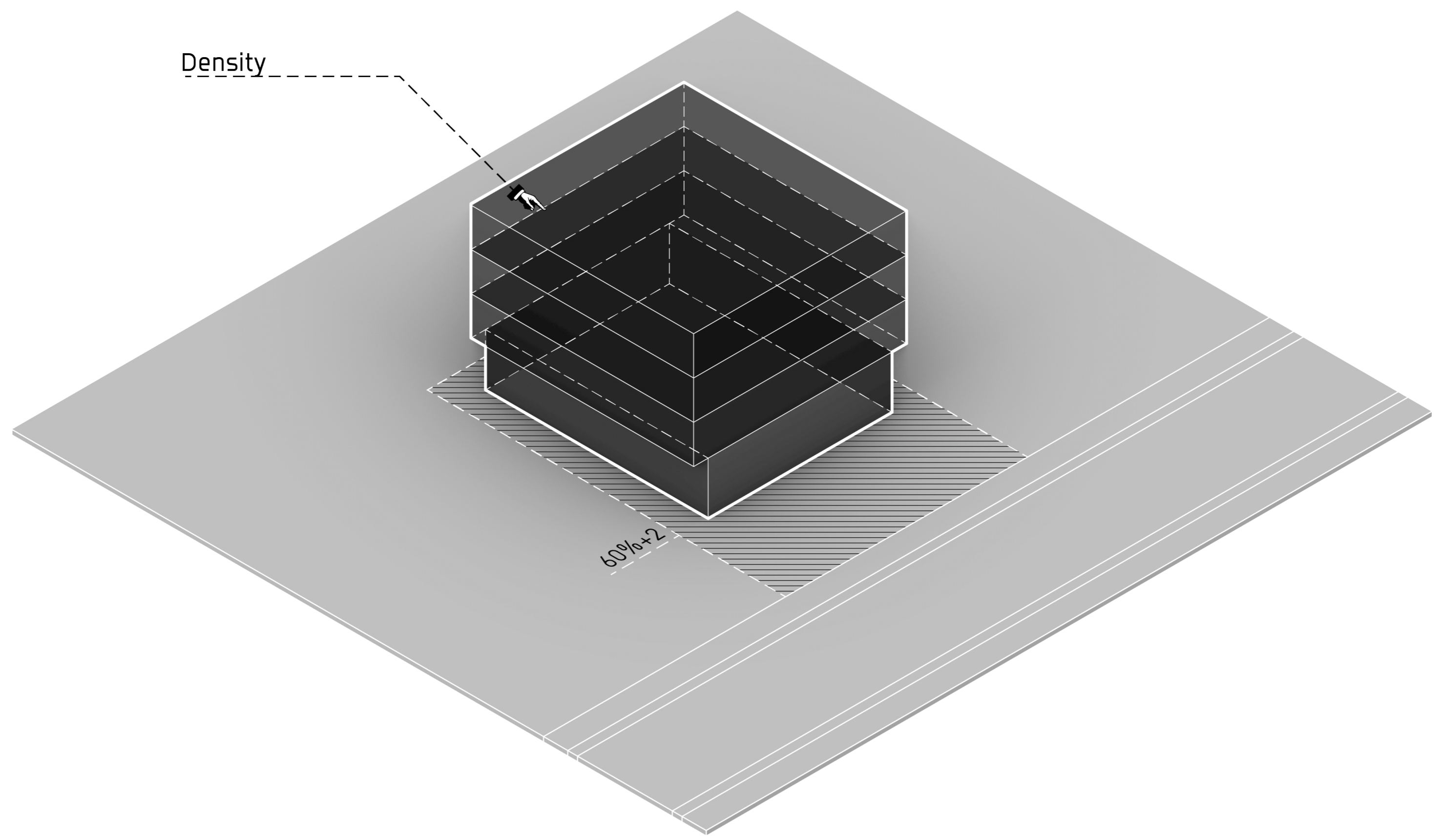

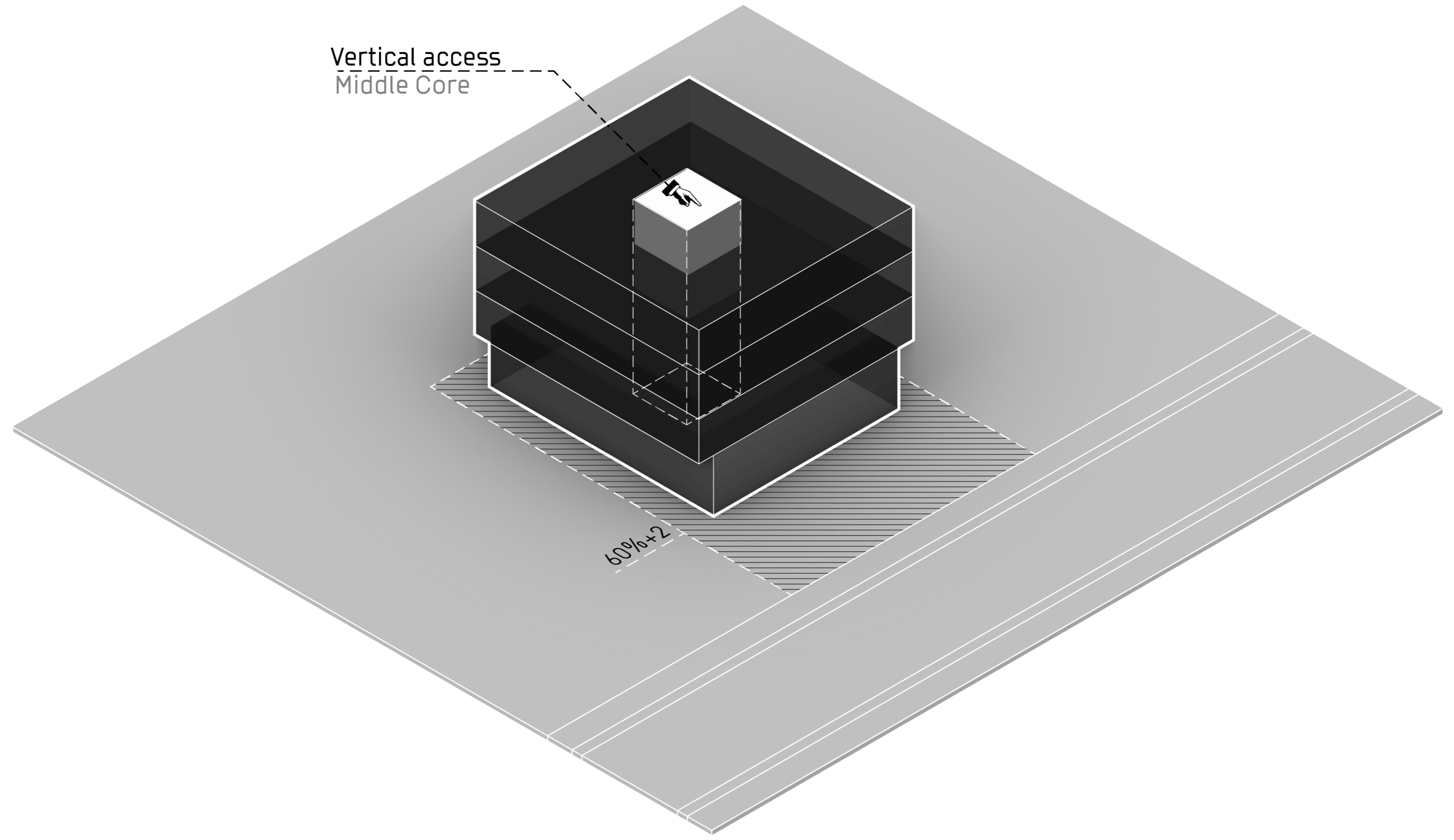

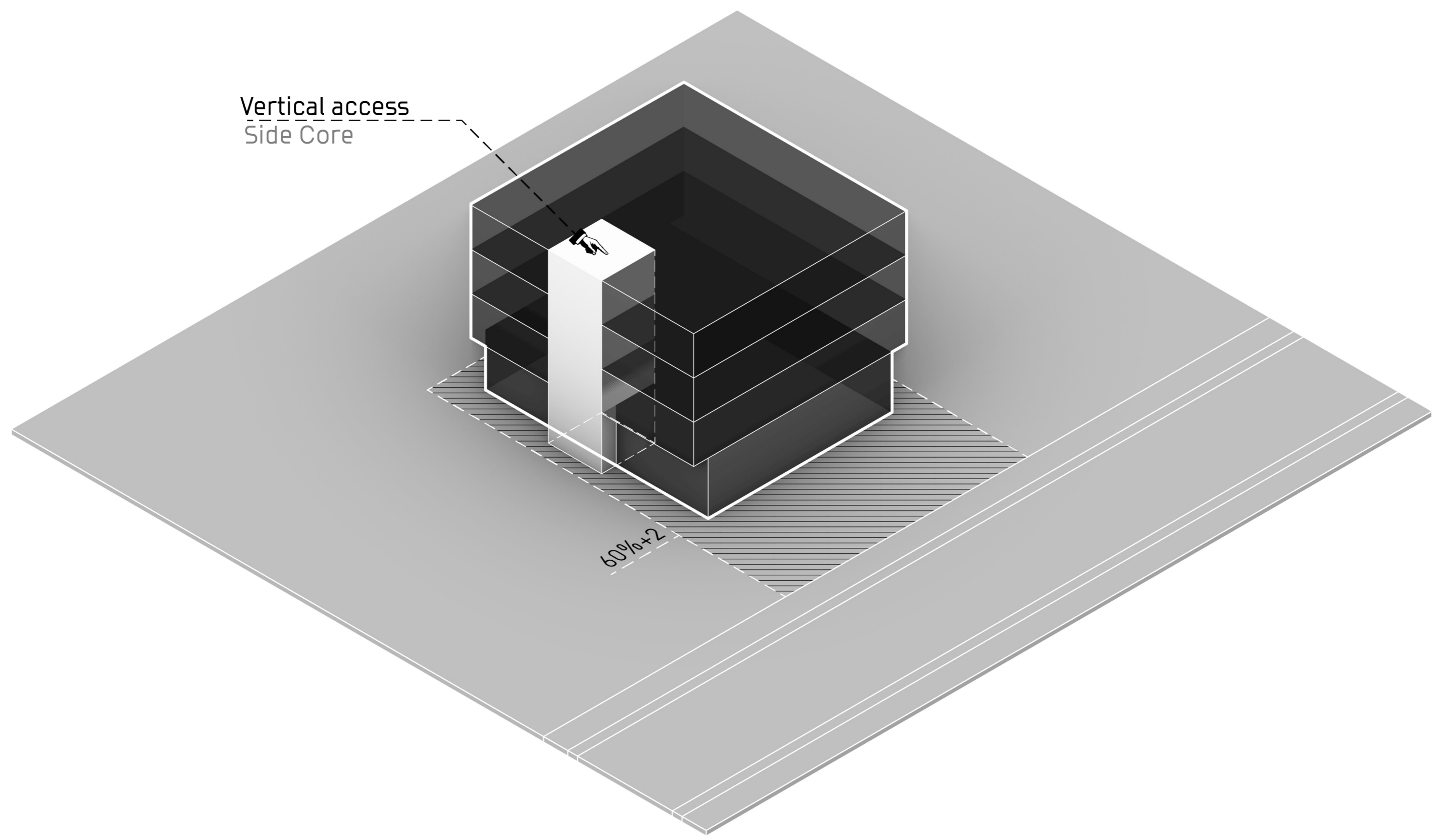

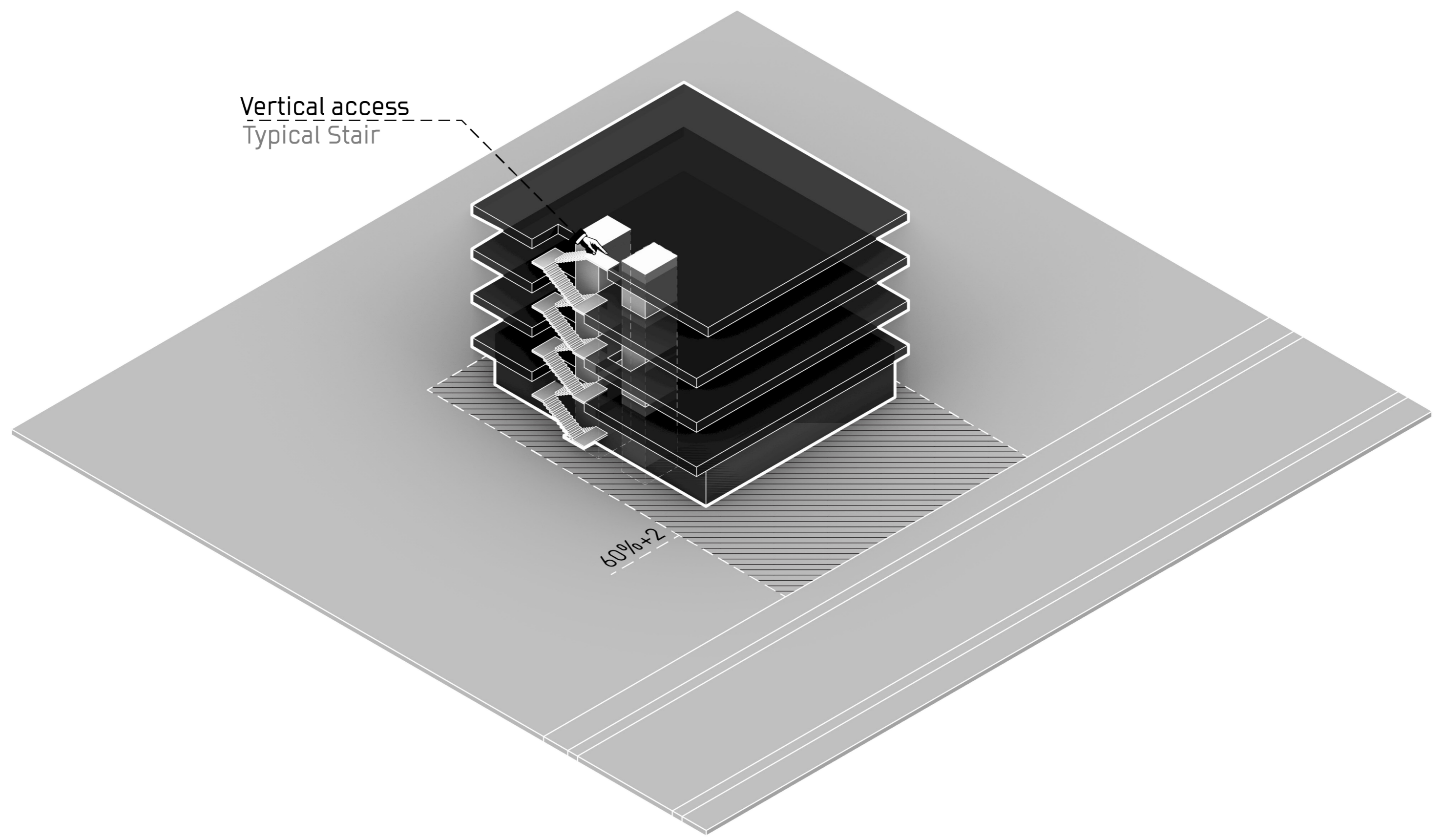

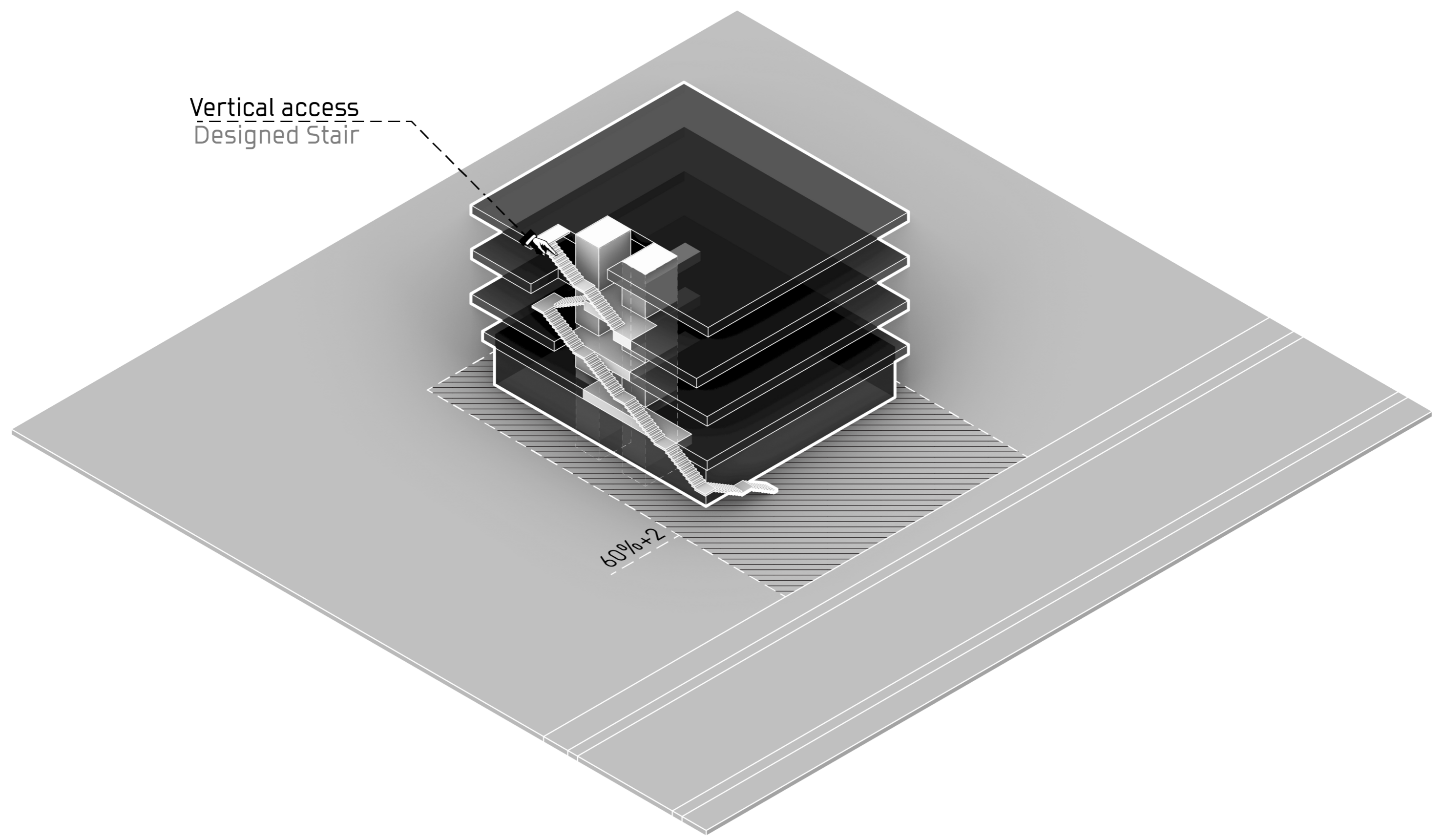

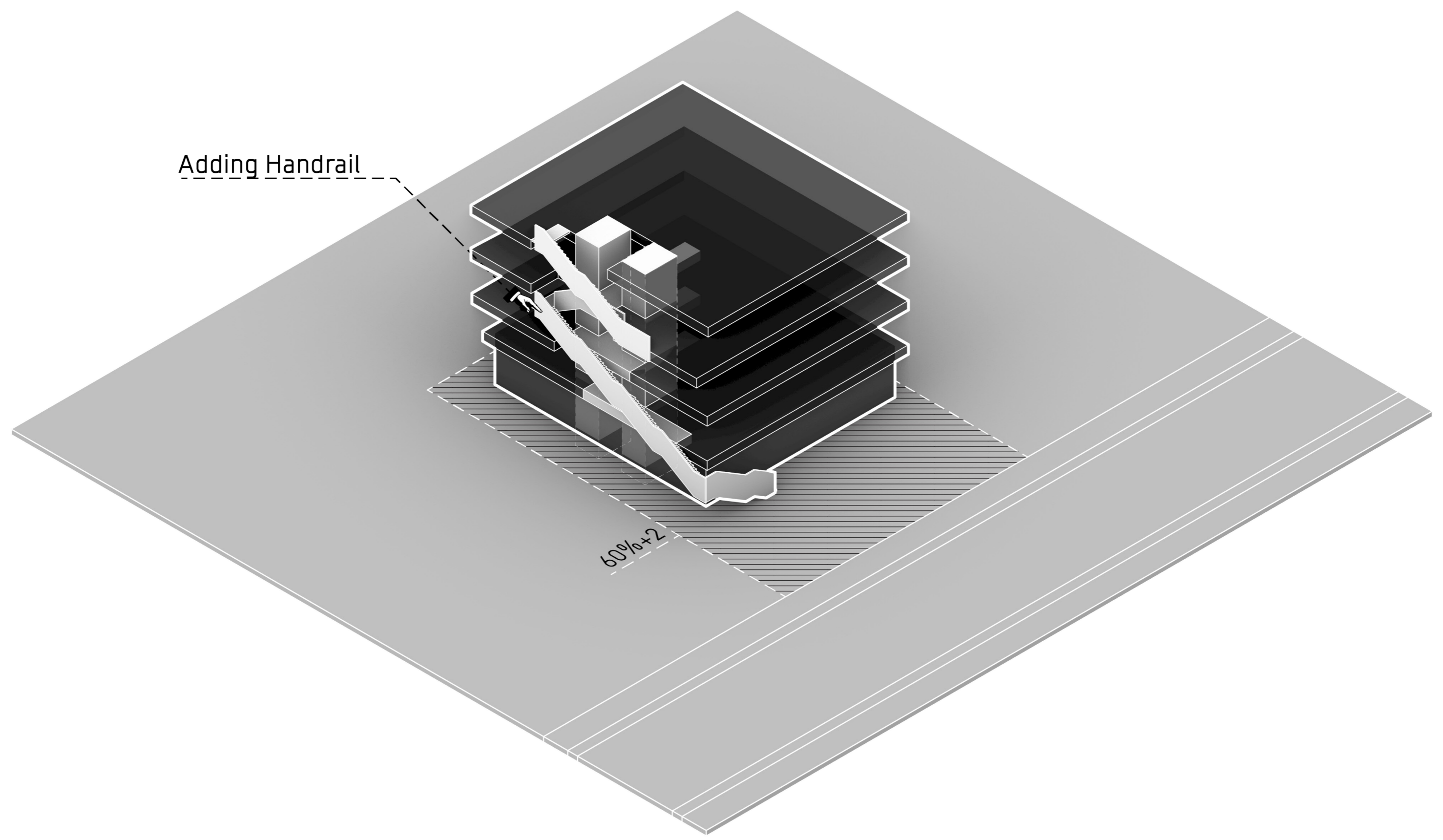

Adding Handrail

60%+2

Adding Sloped Roof

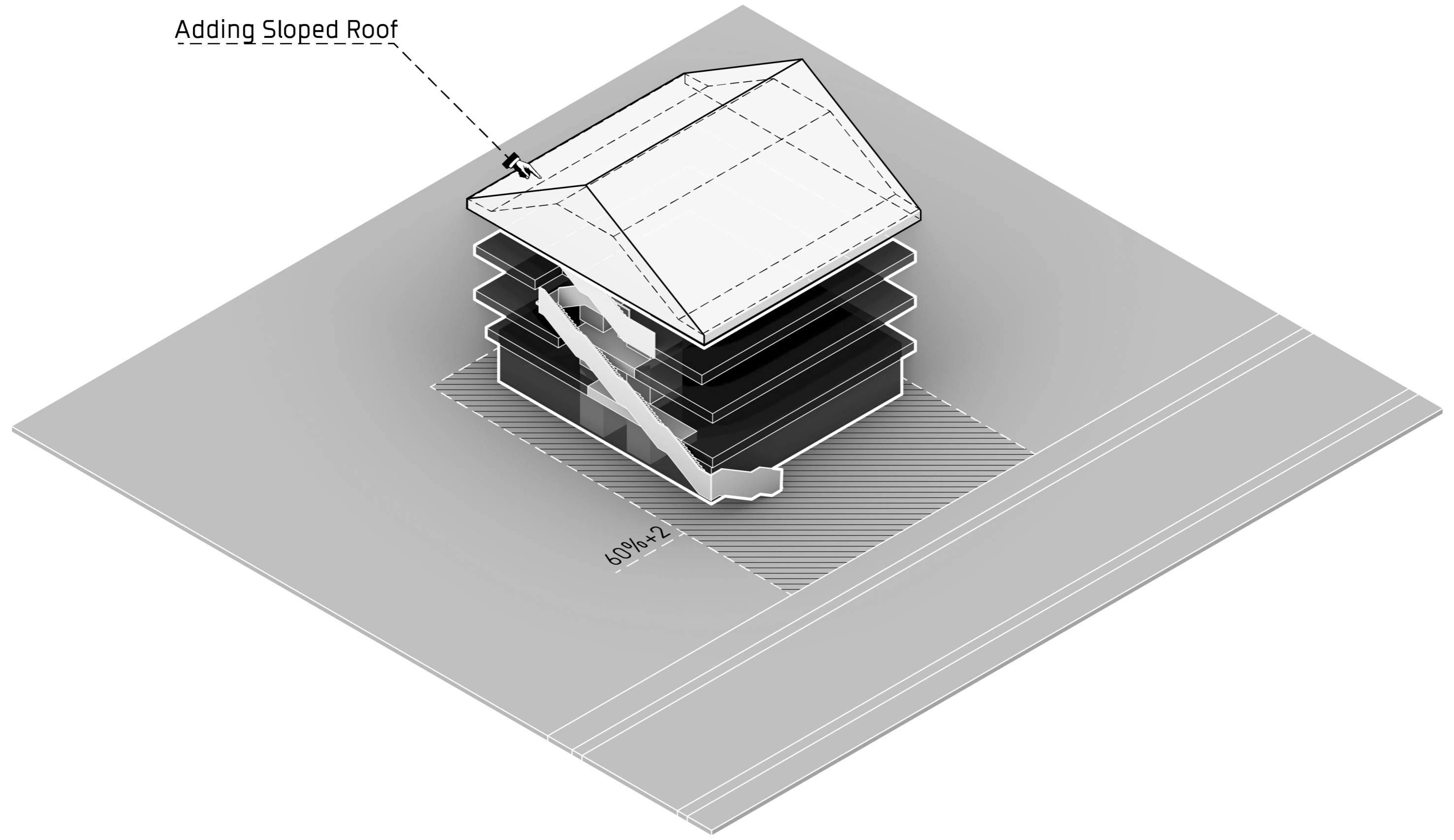

Terraced Stair Form

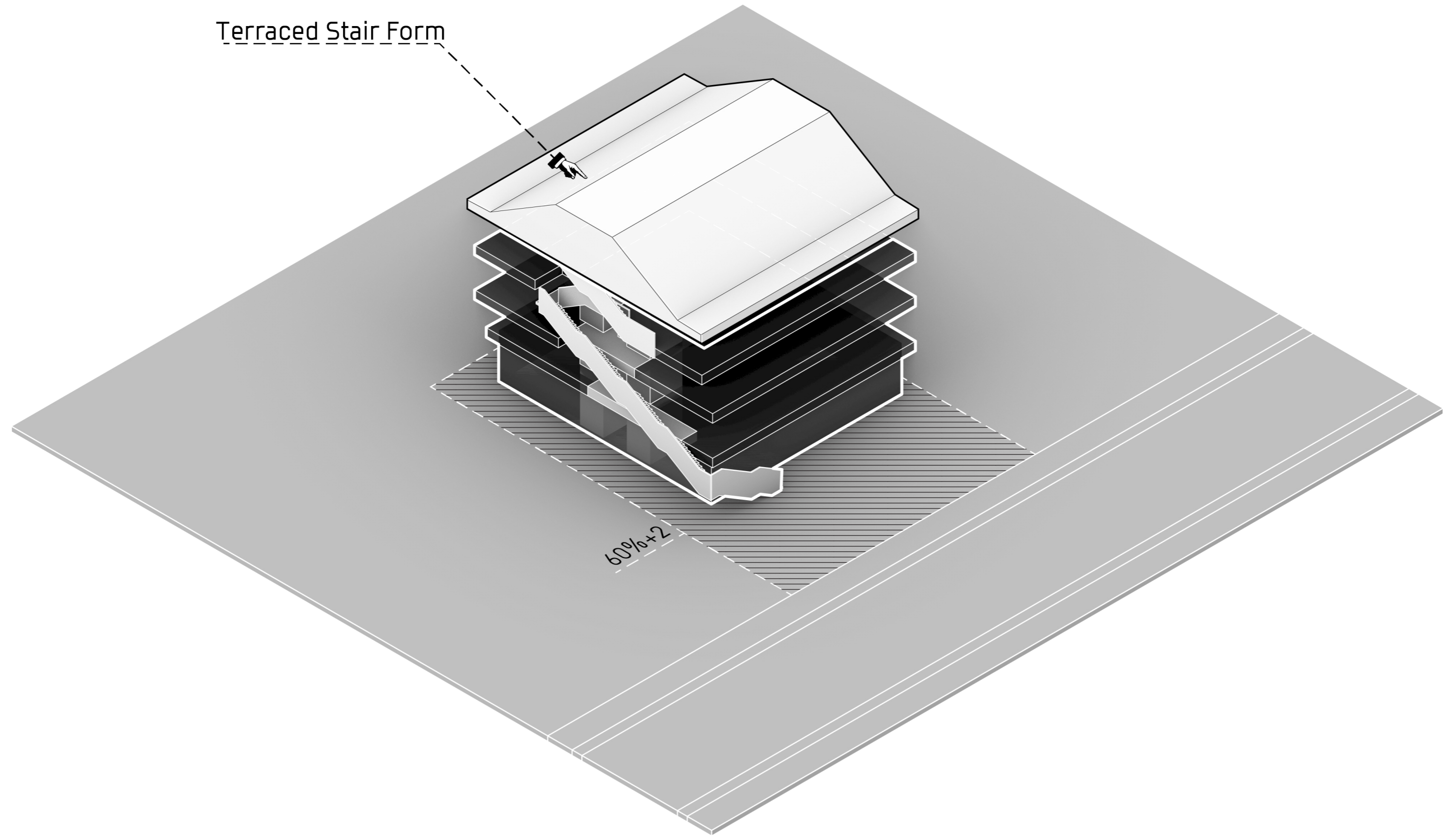

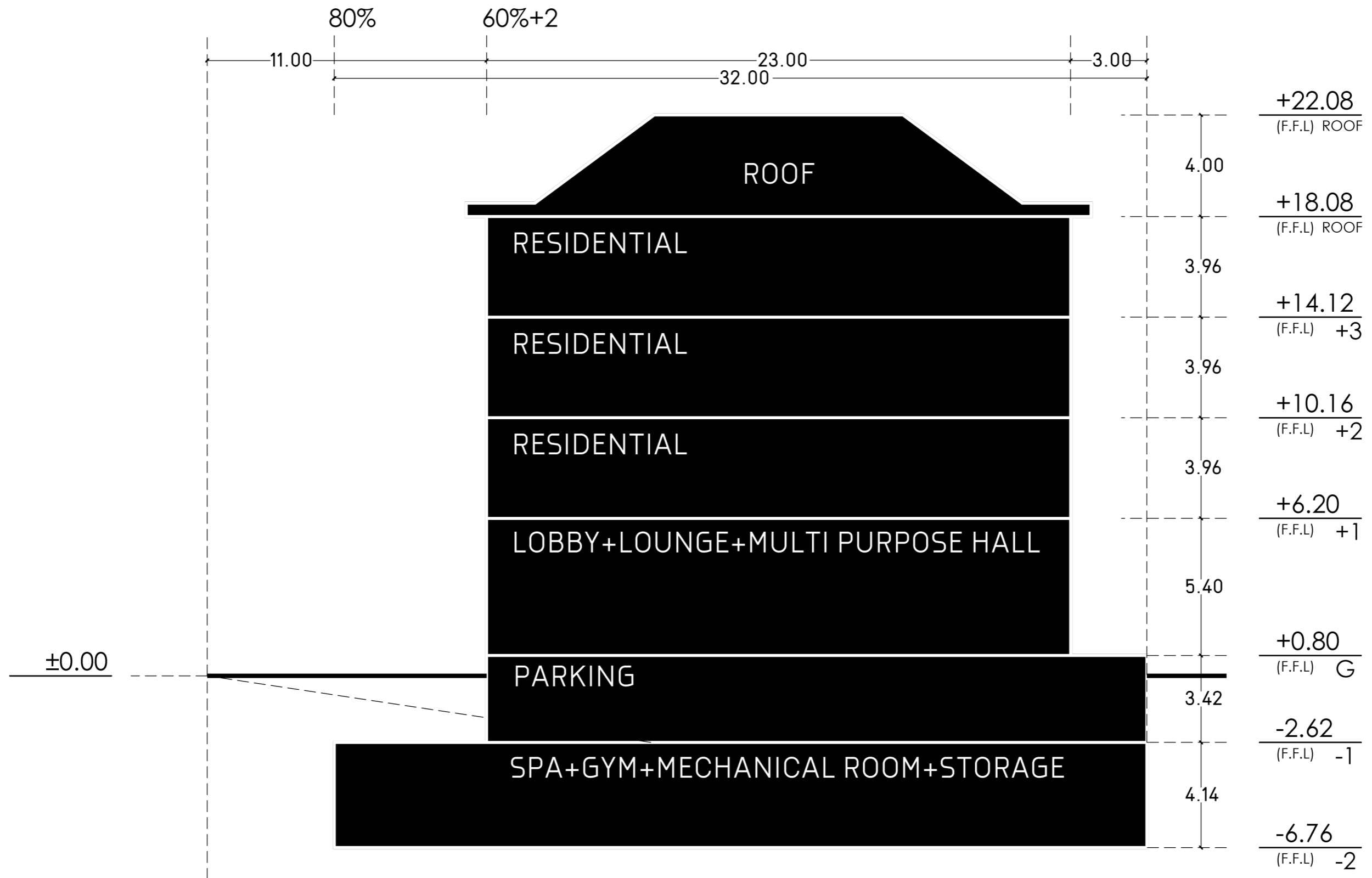

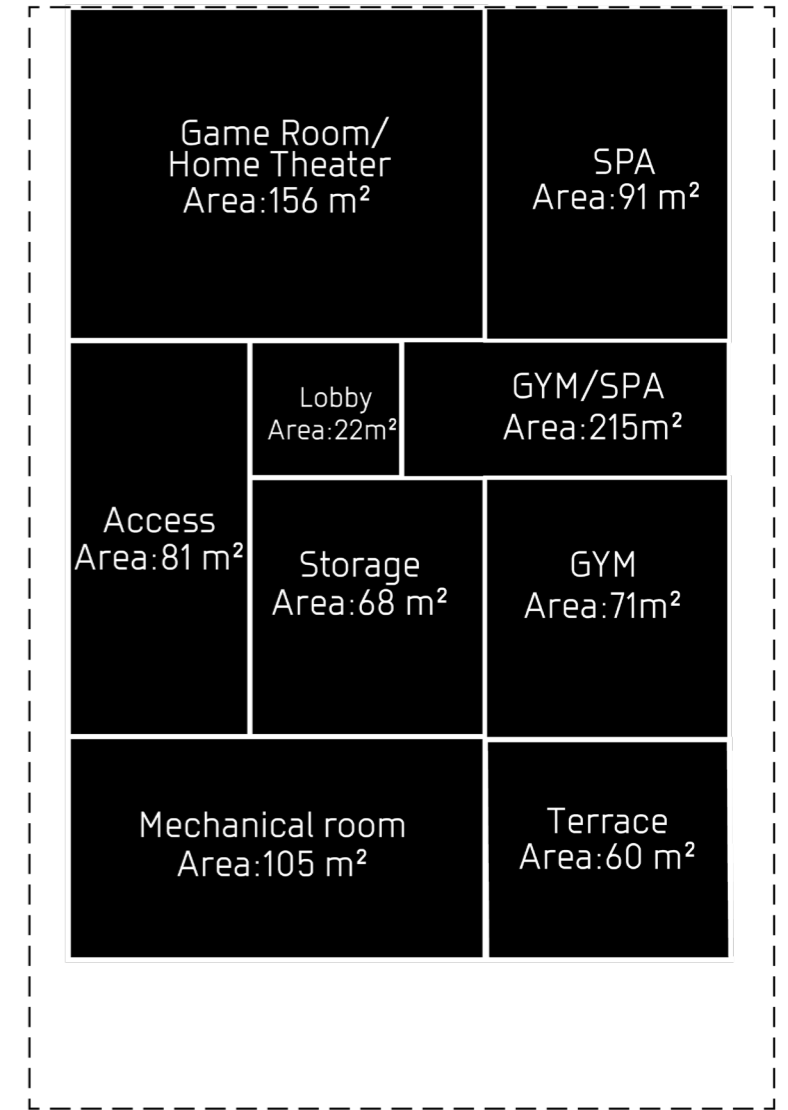
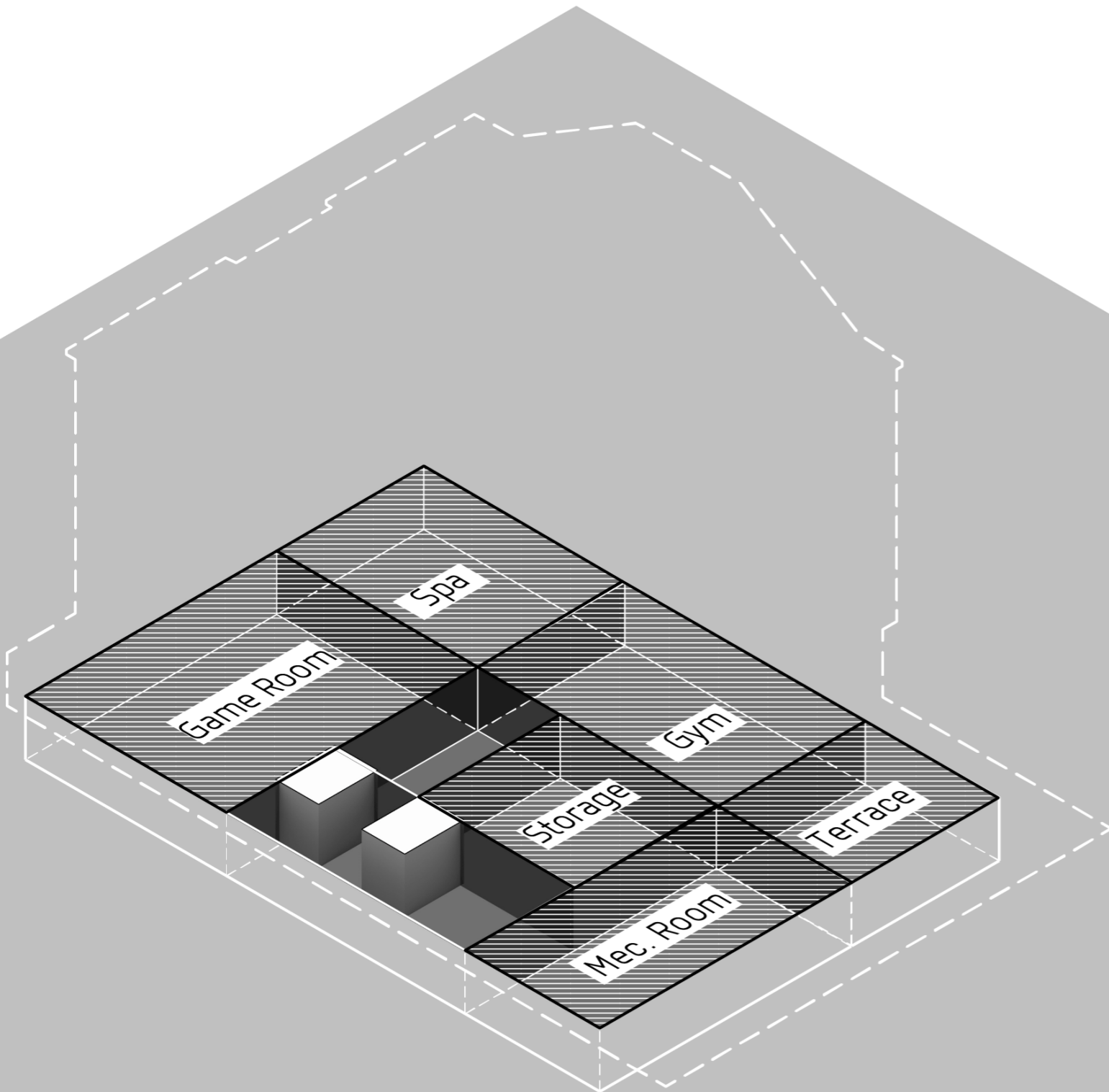

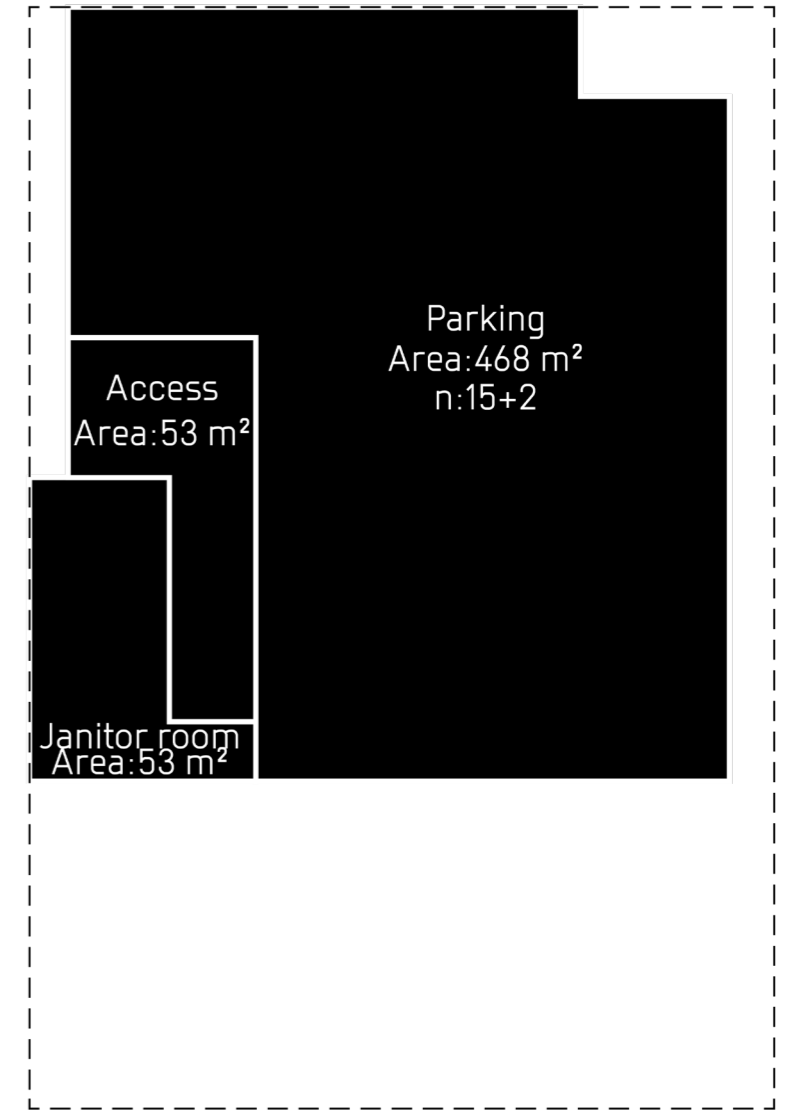
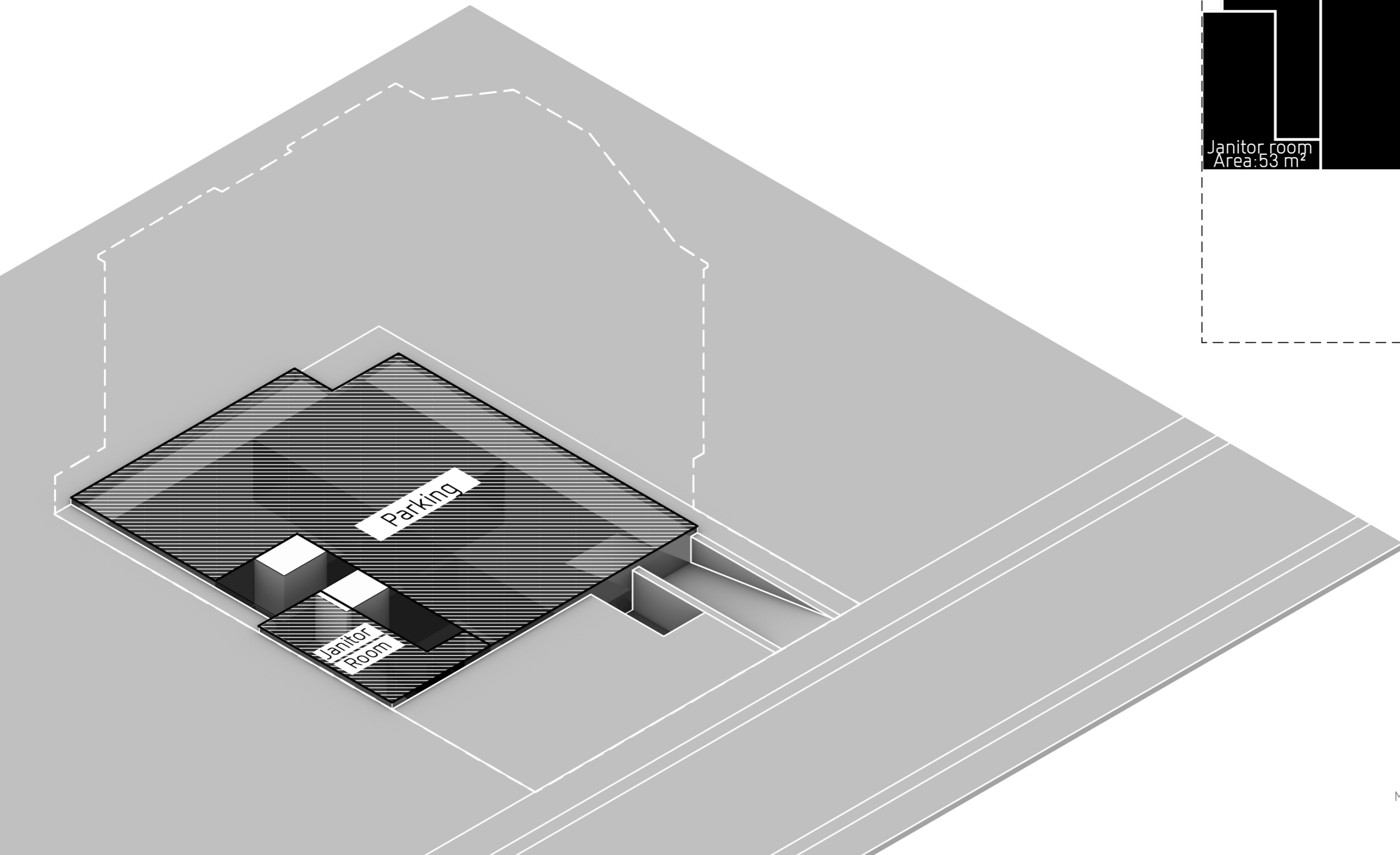

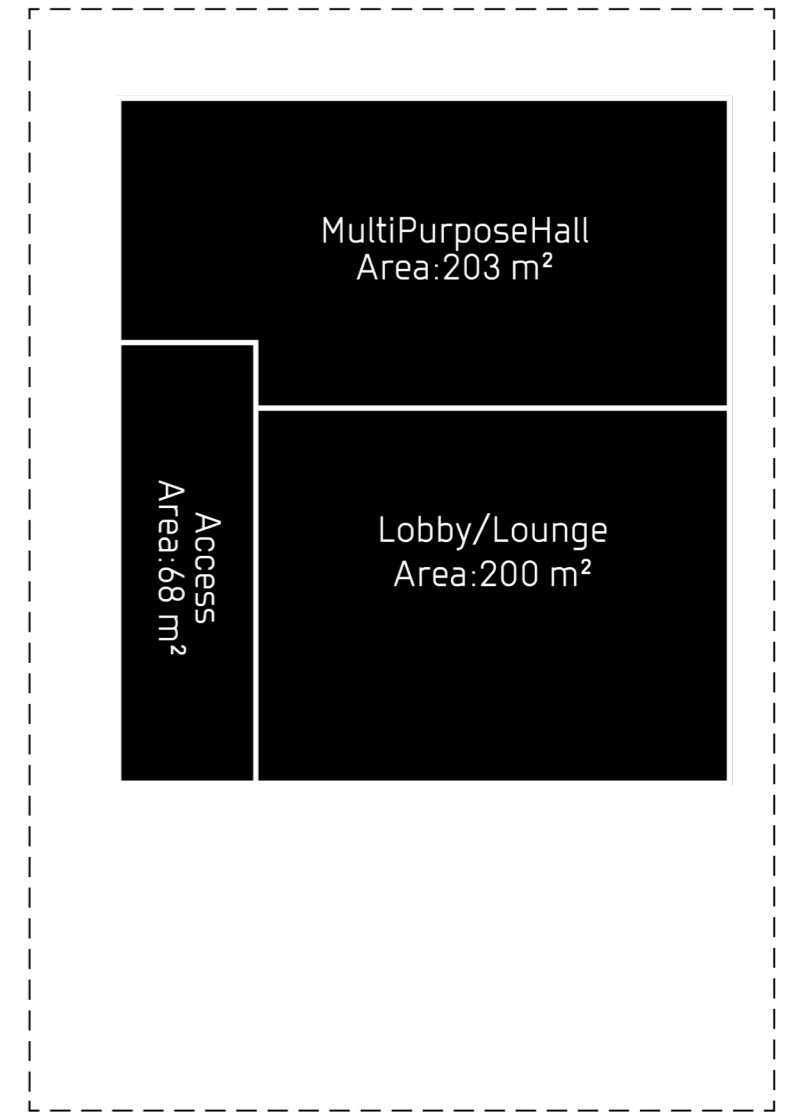
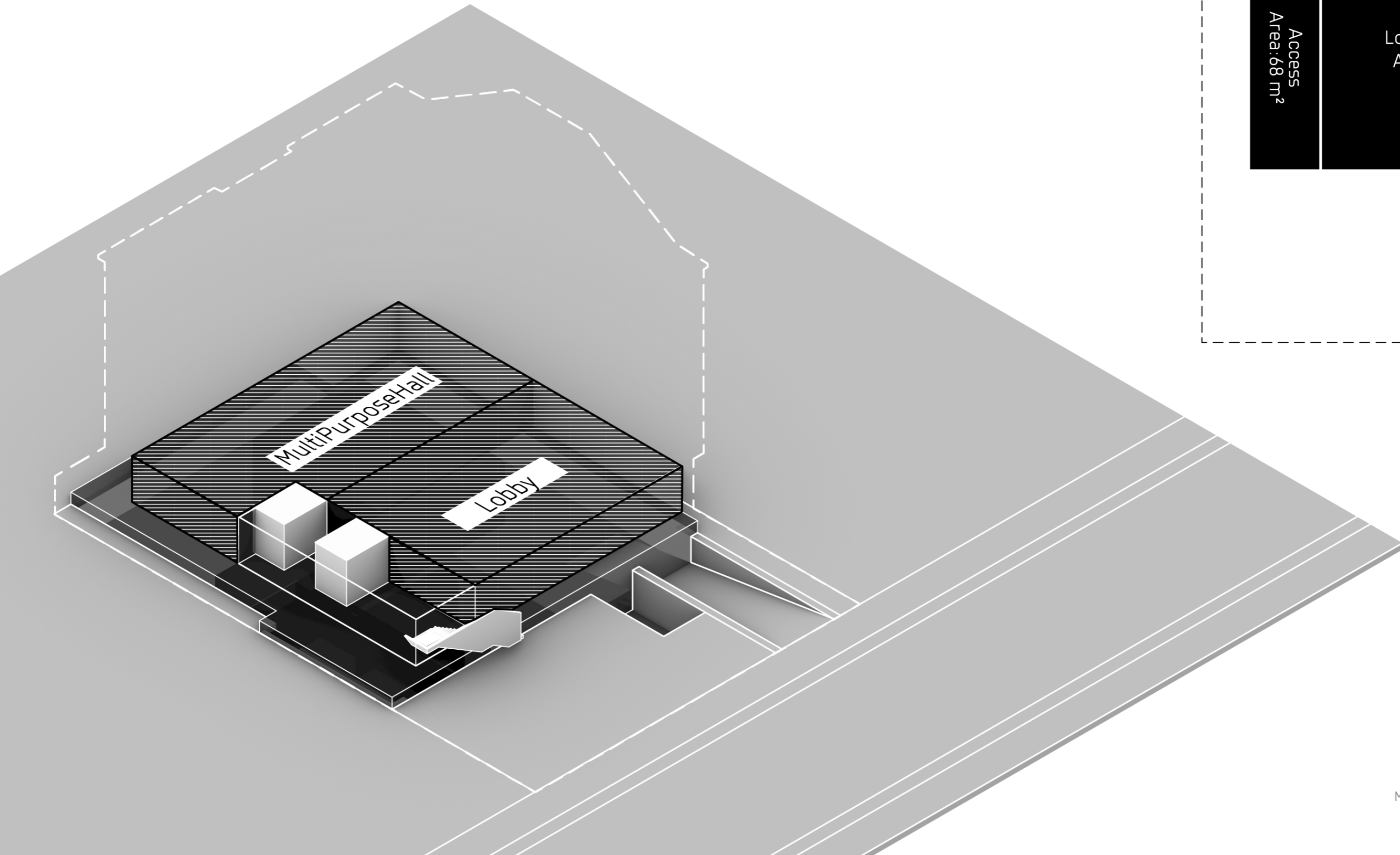

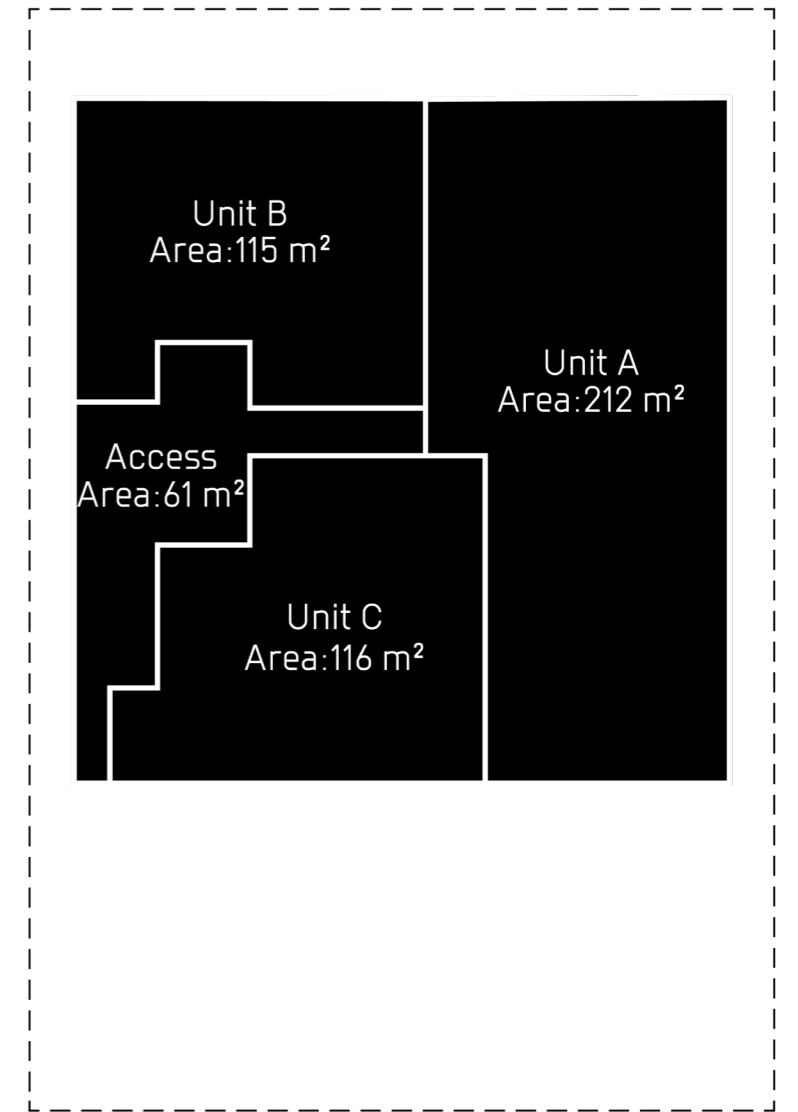
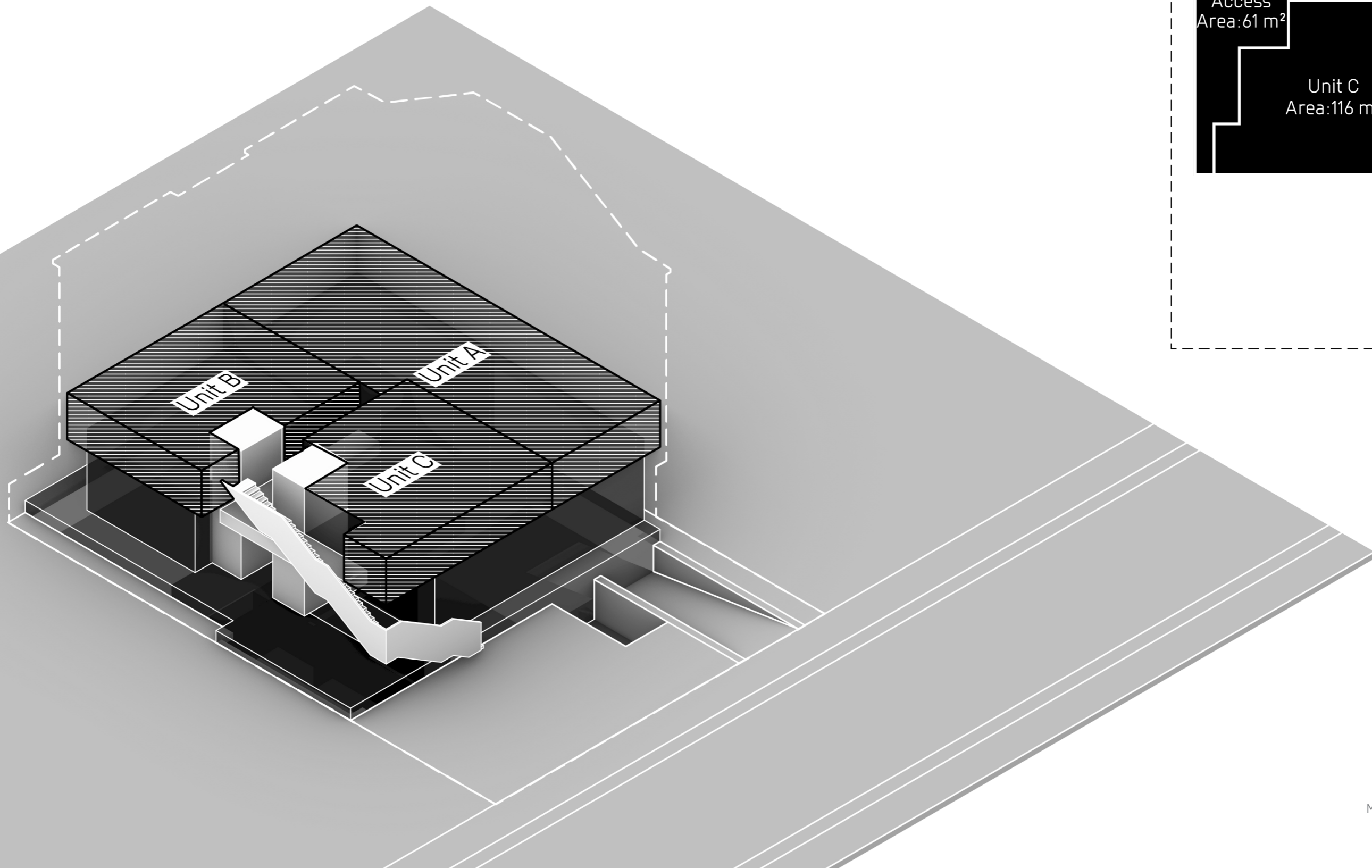

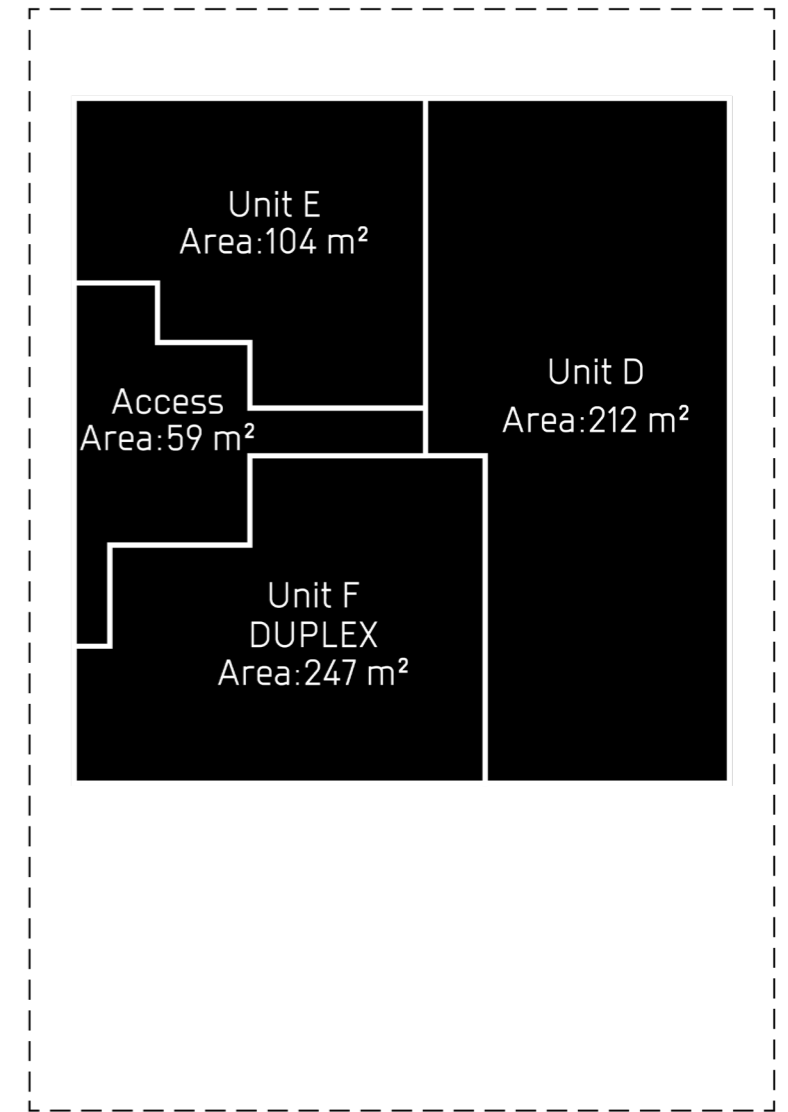
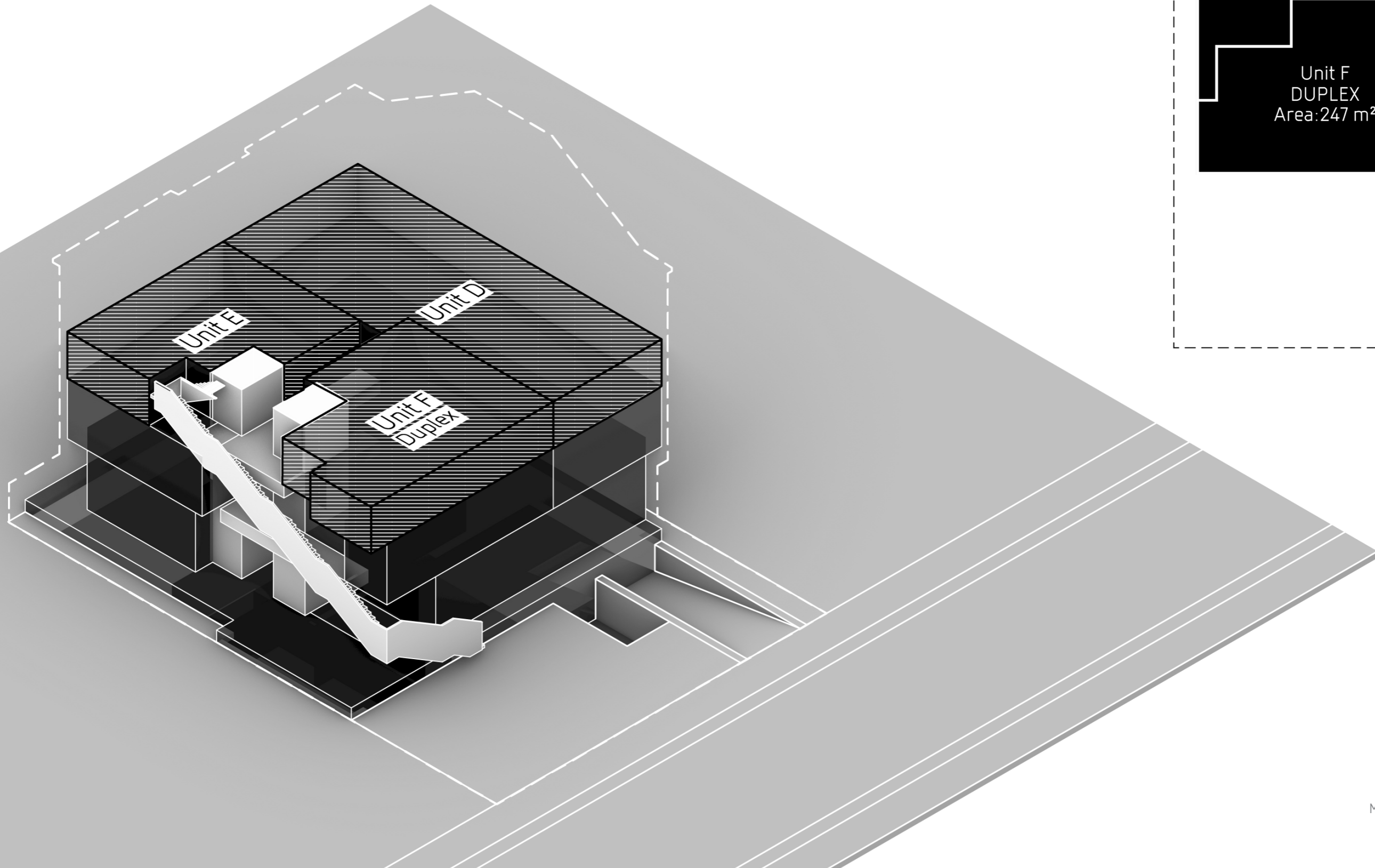

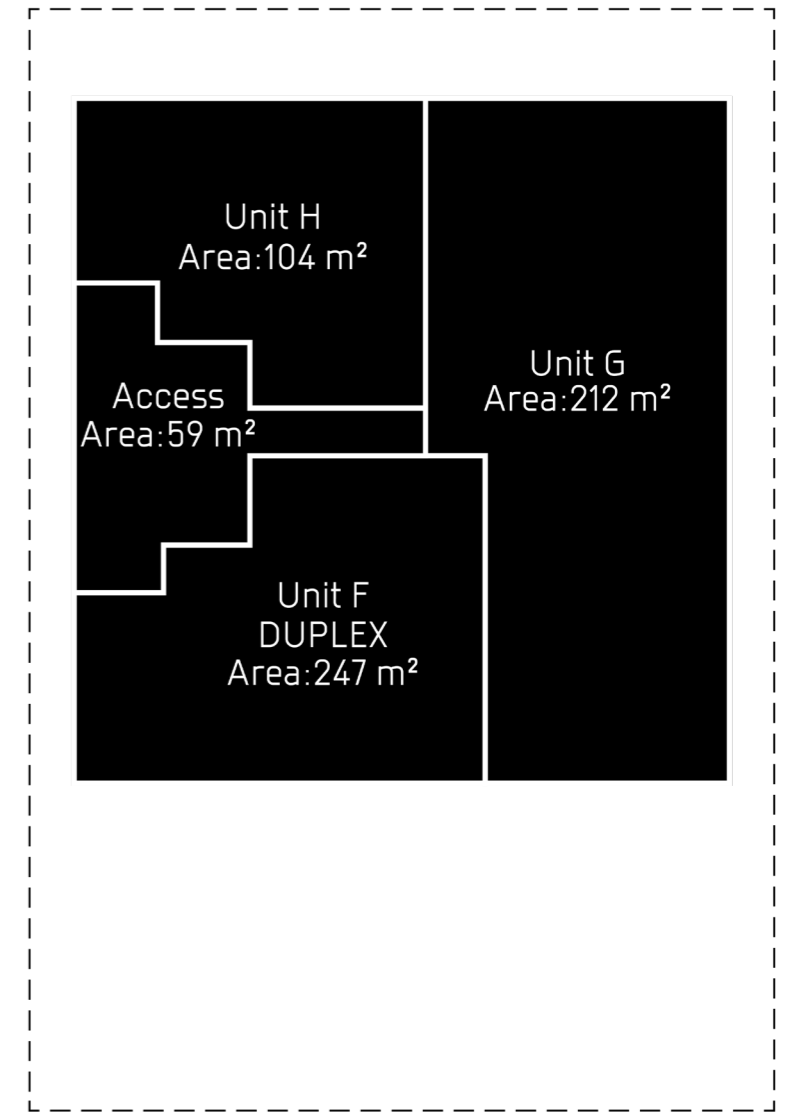
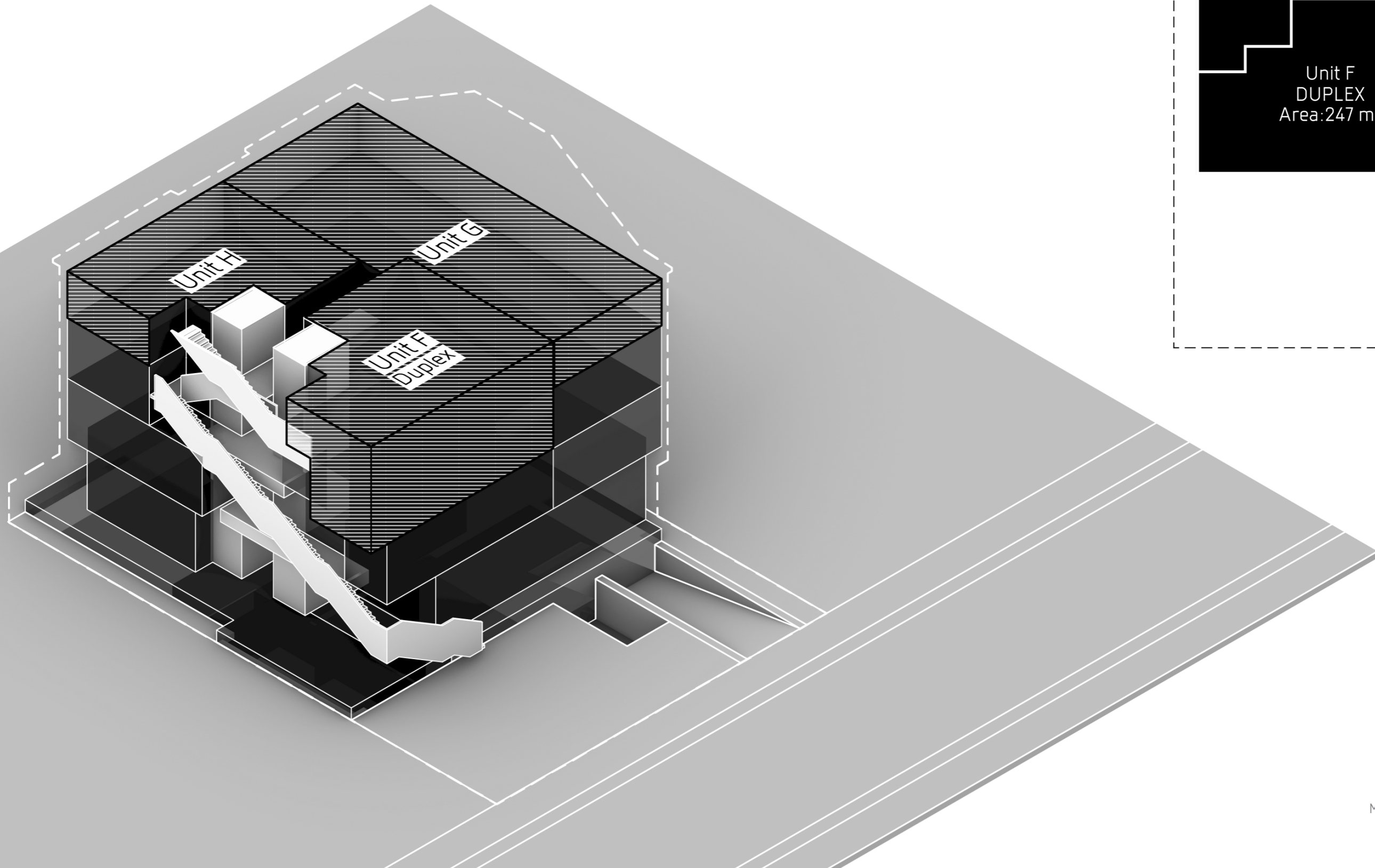

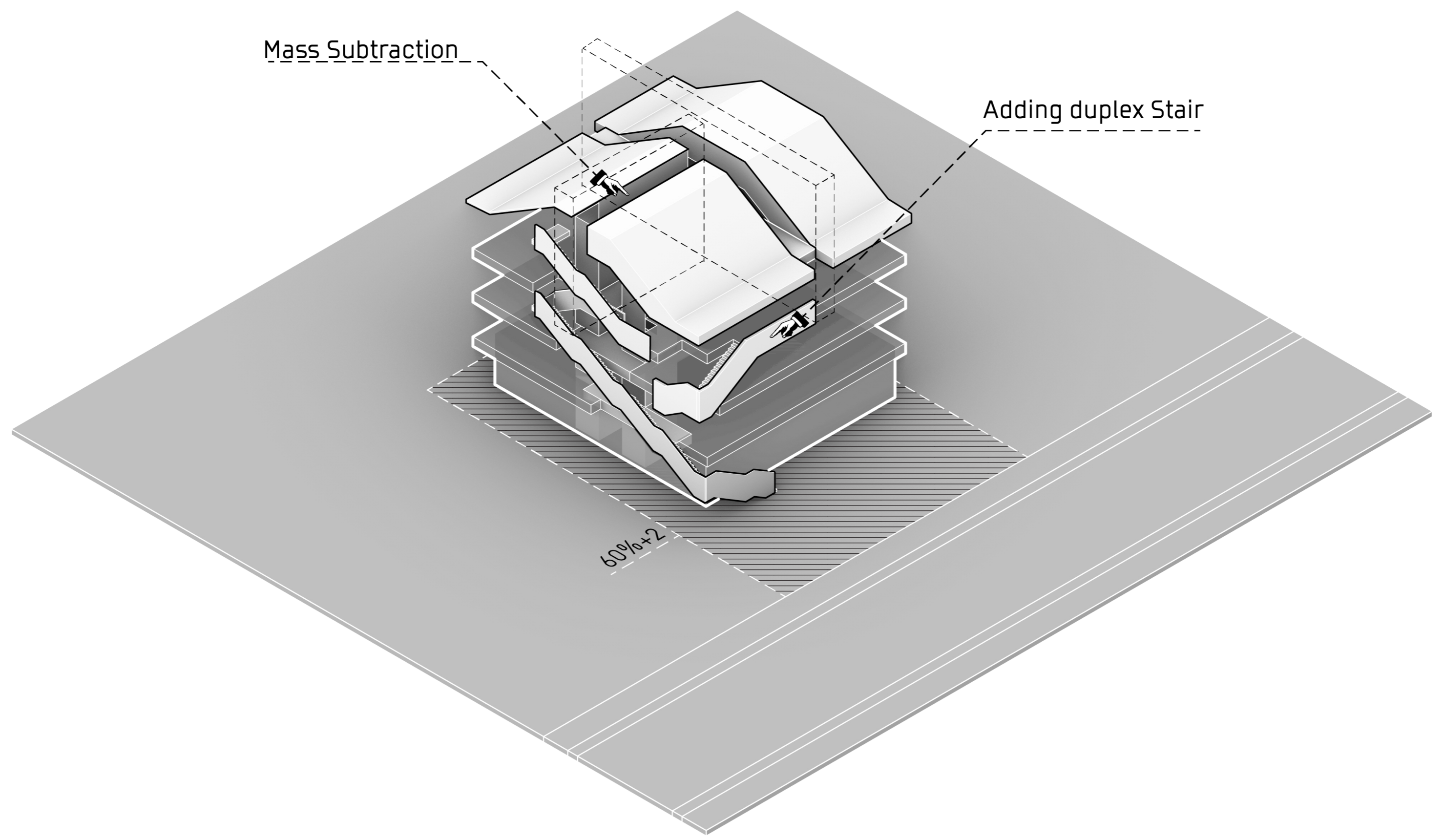

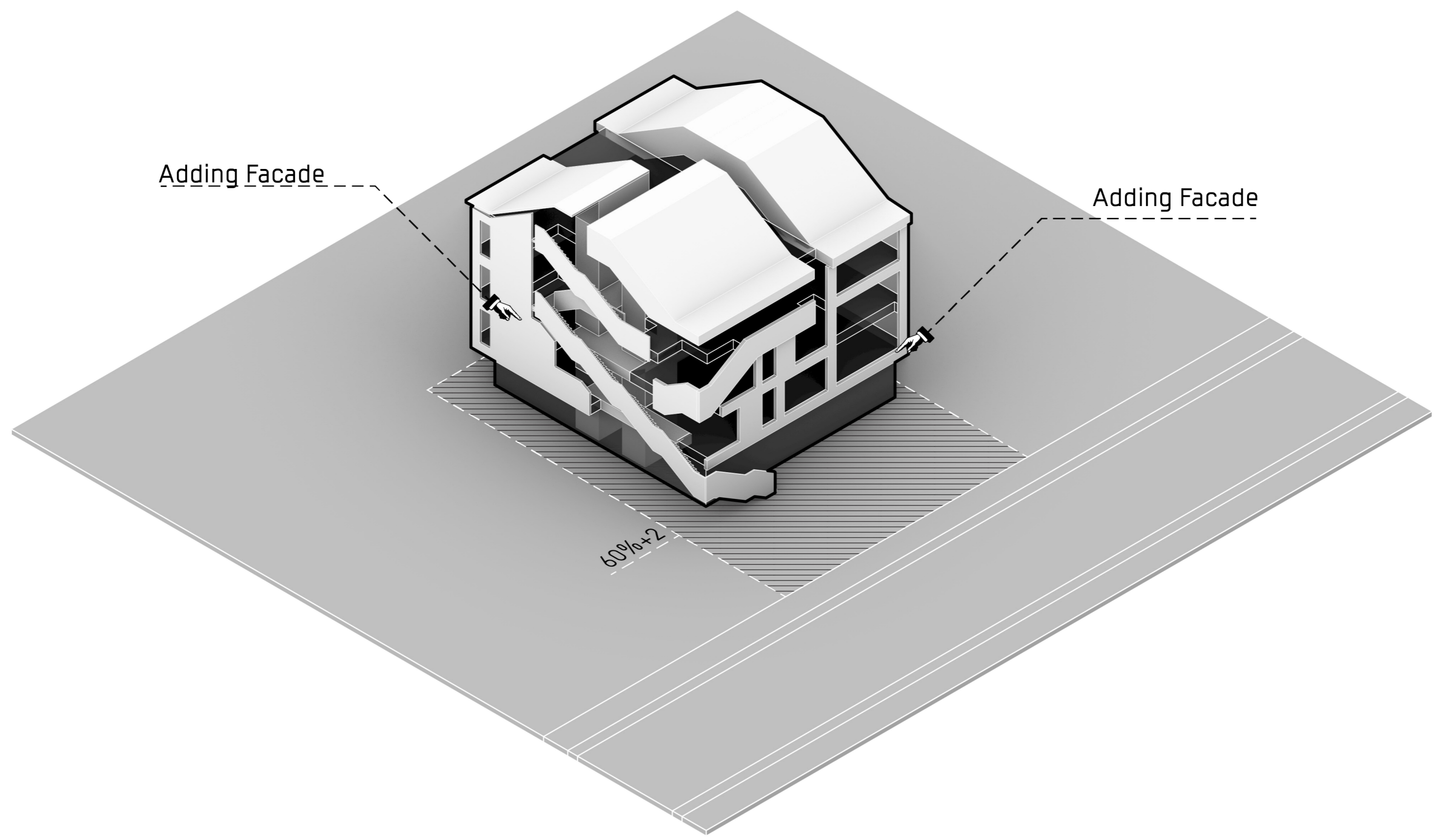

Done!

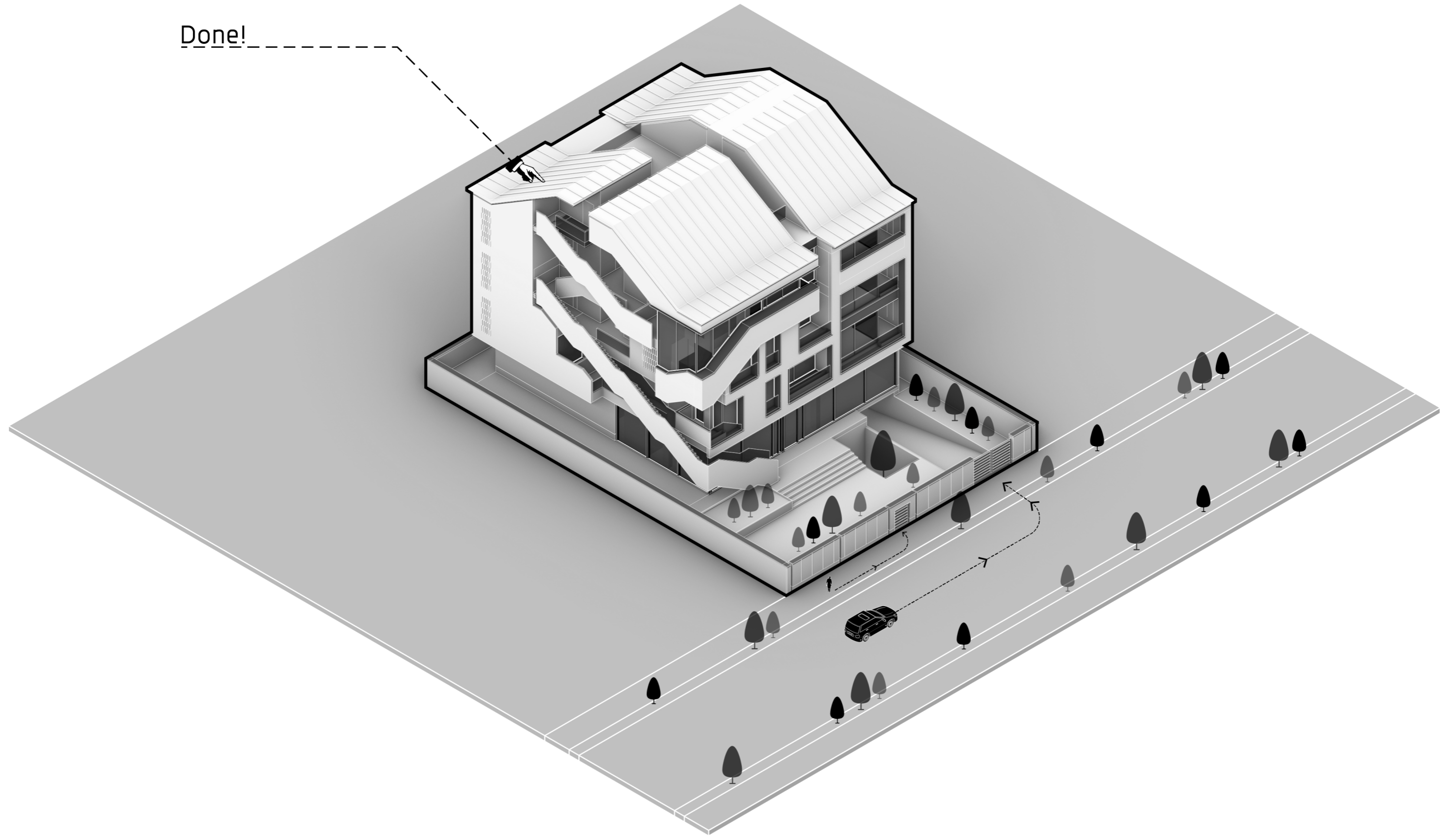

PLANS

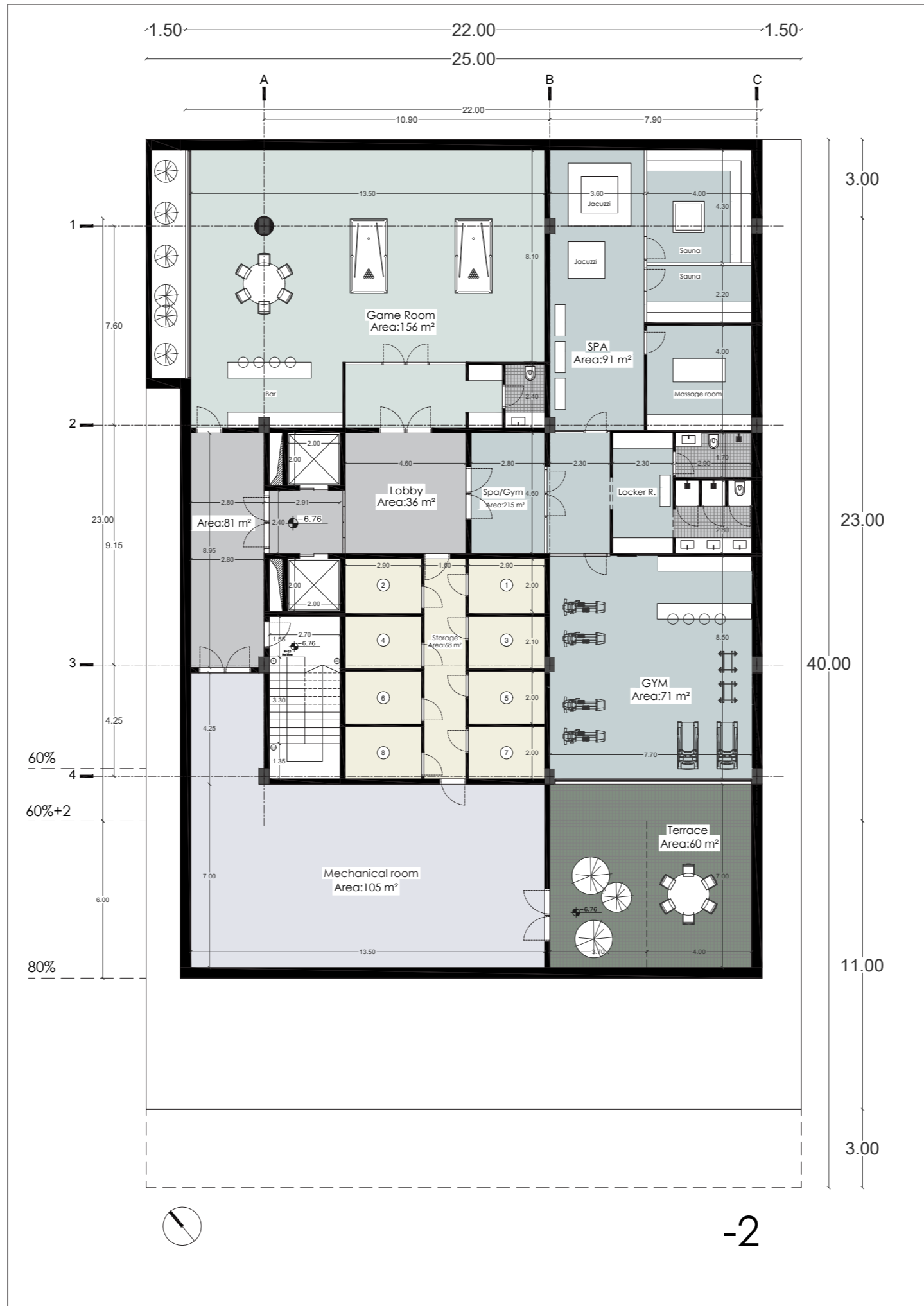

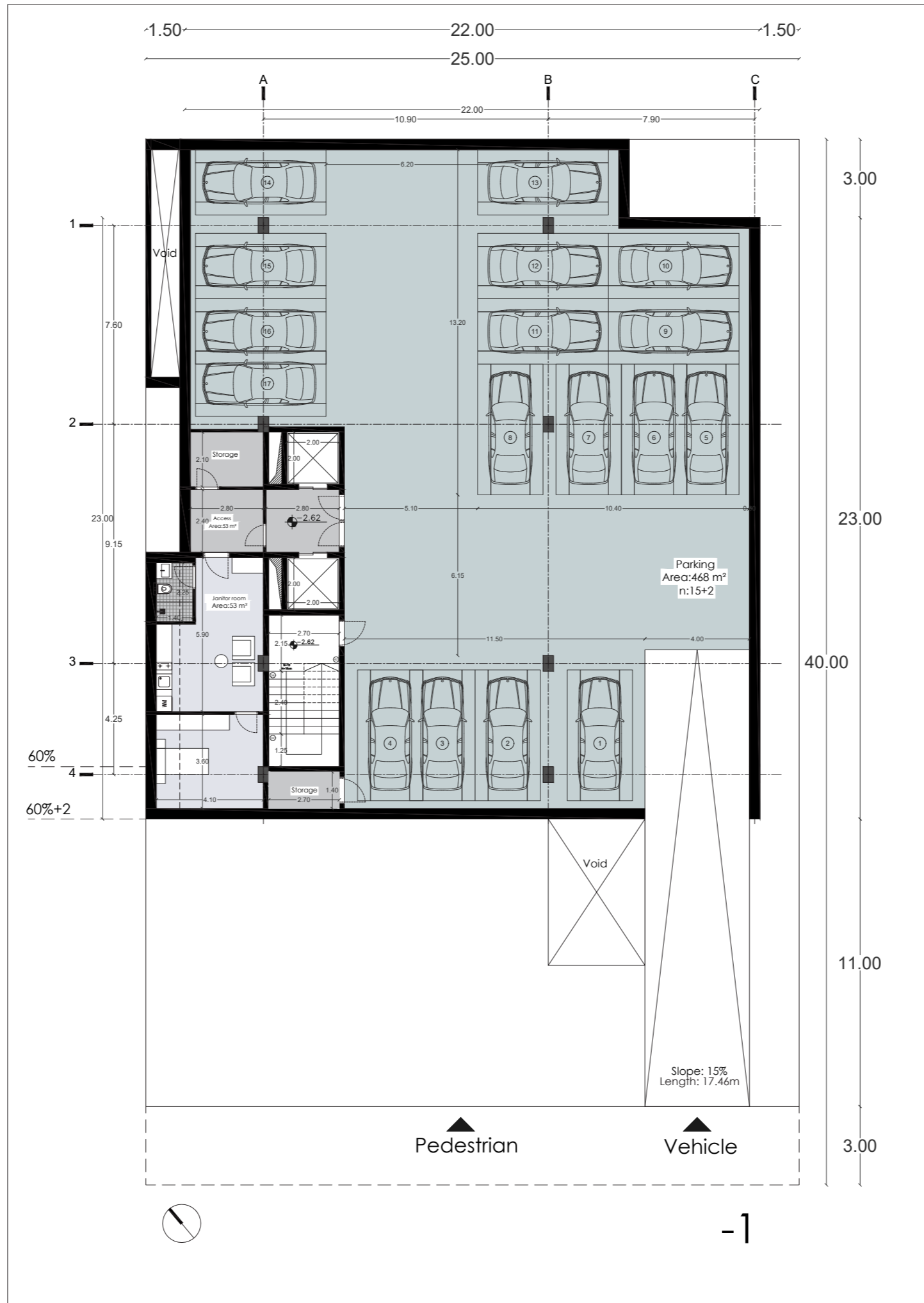

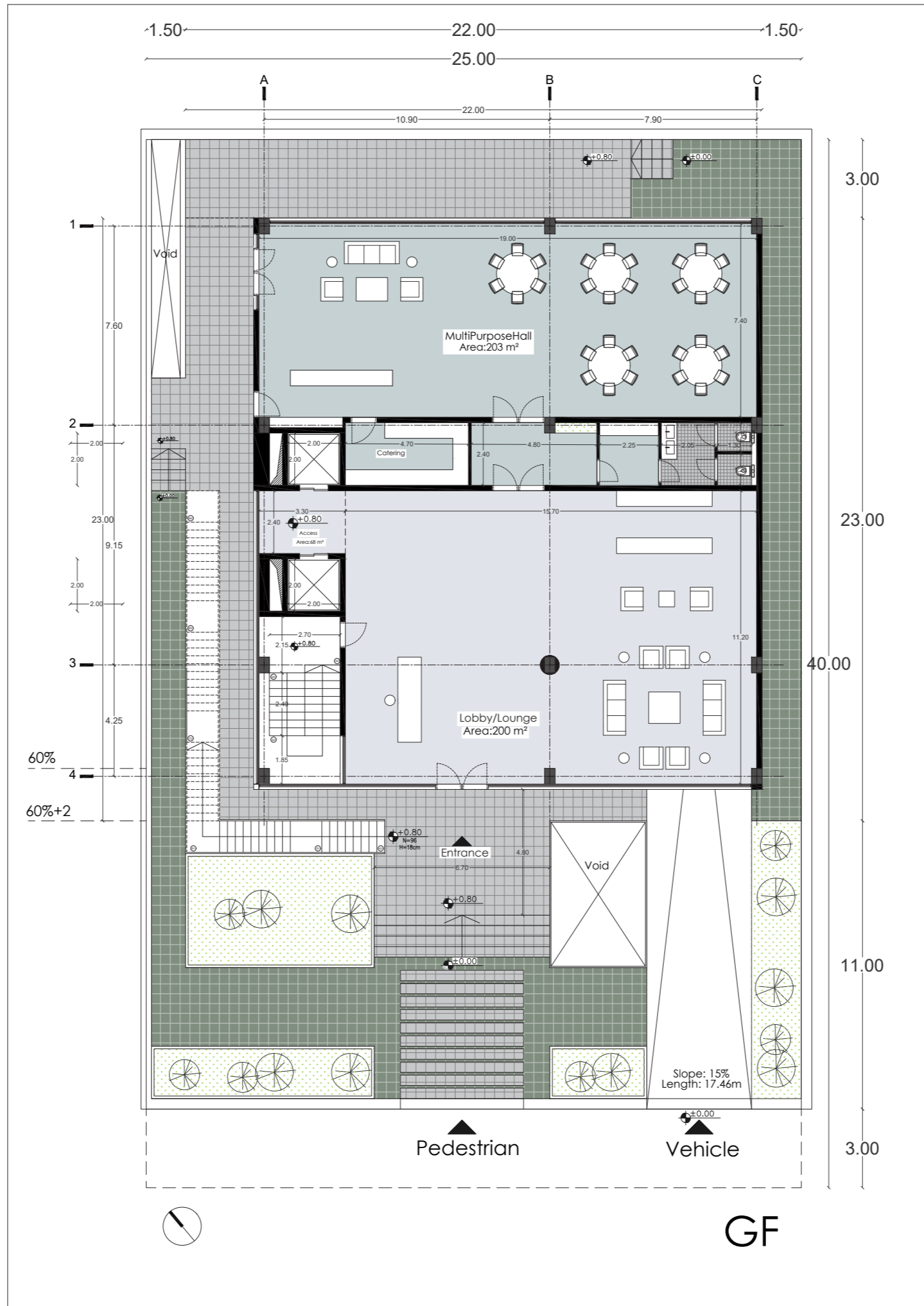

Plan  
+1





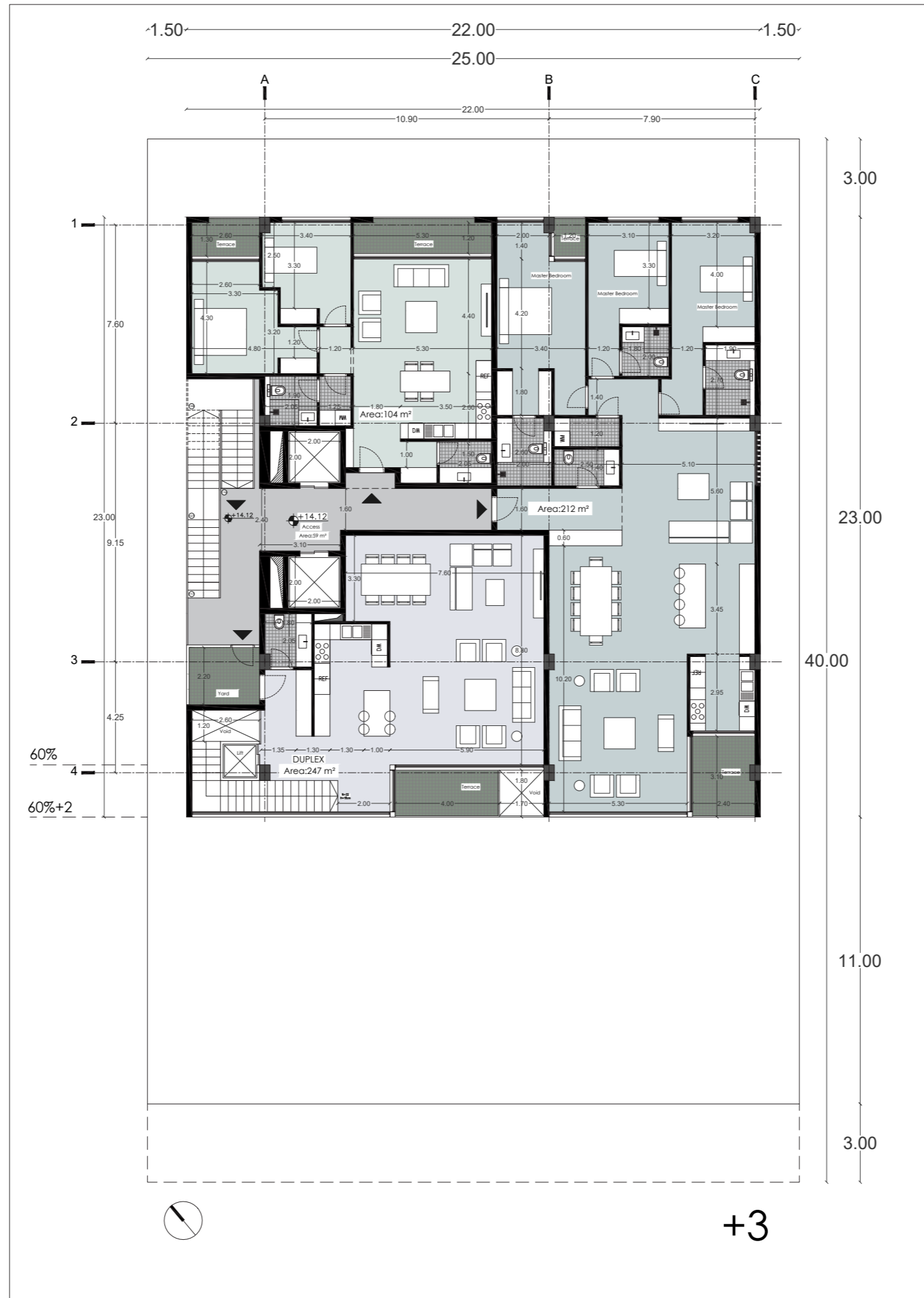

Plan  
ROOF

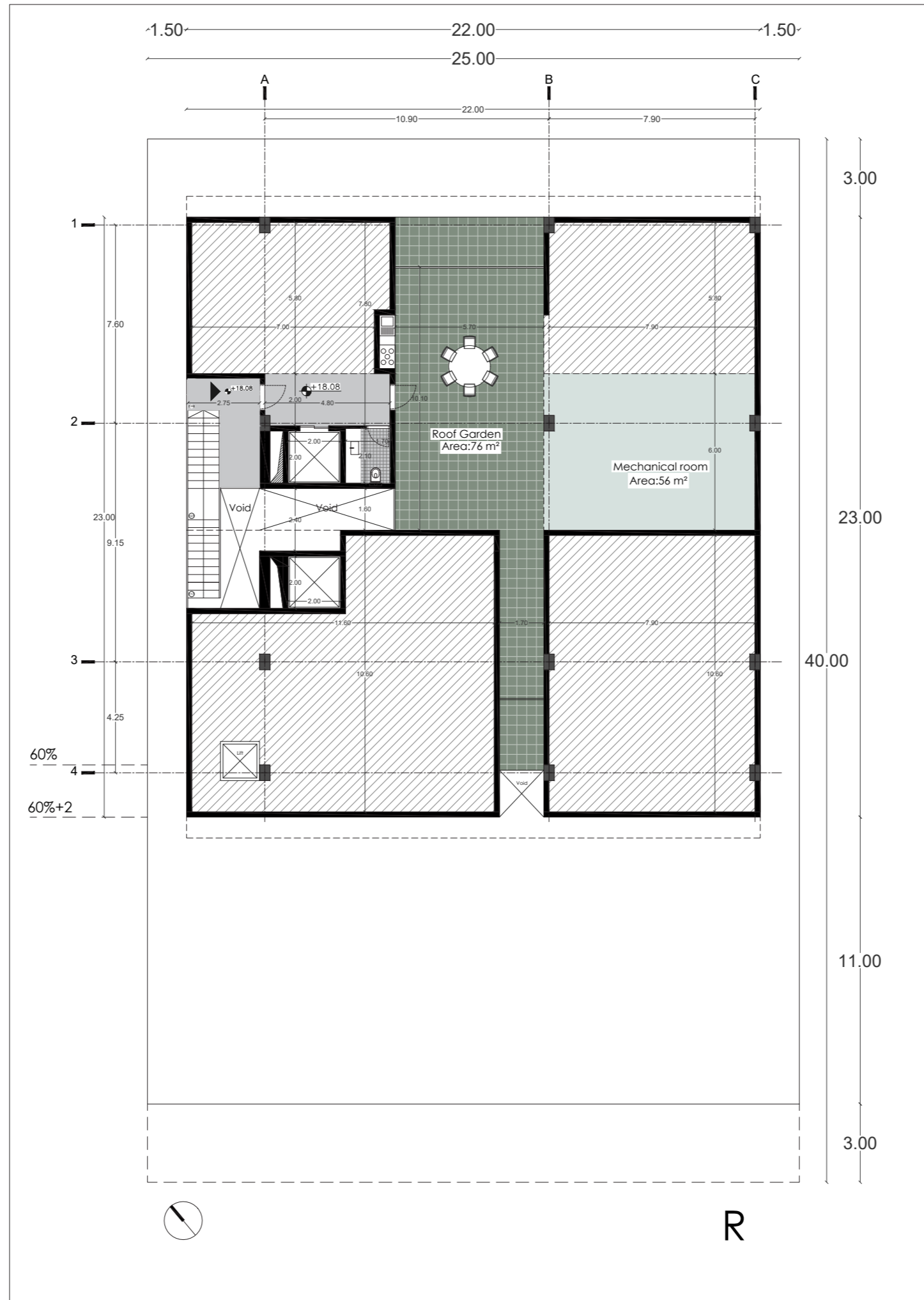

Plan  
SITE PLAN

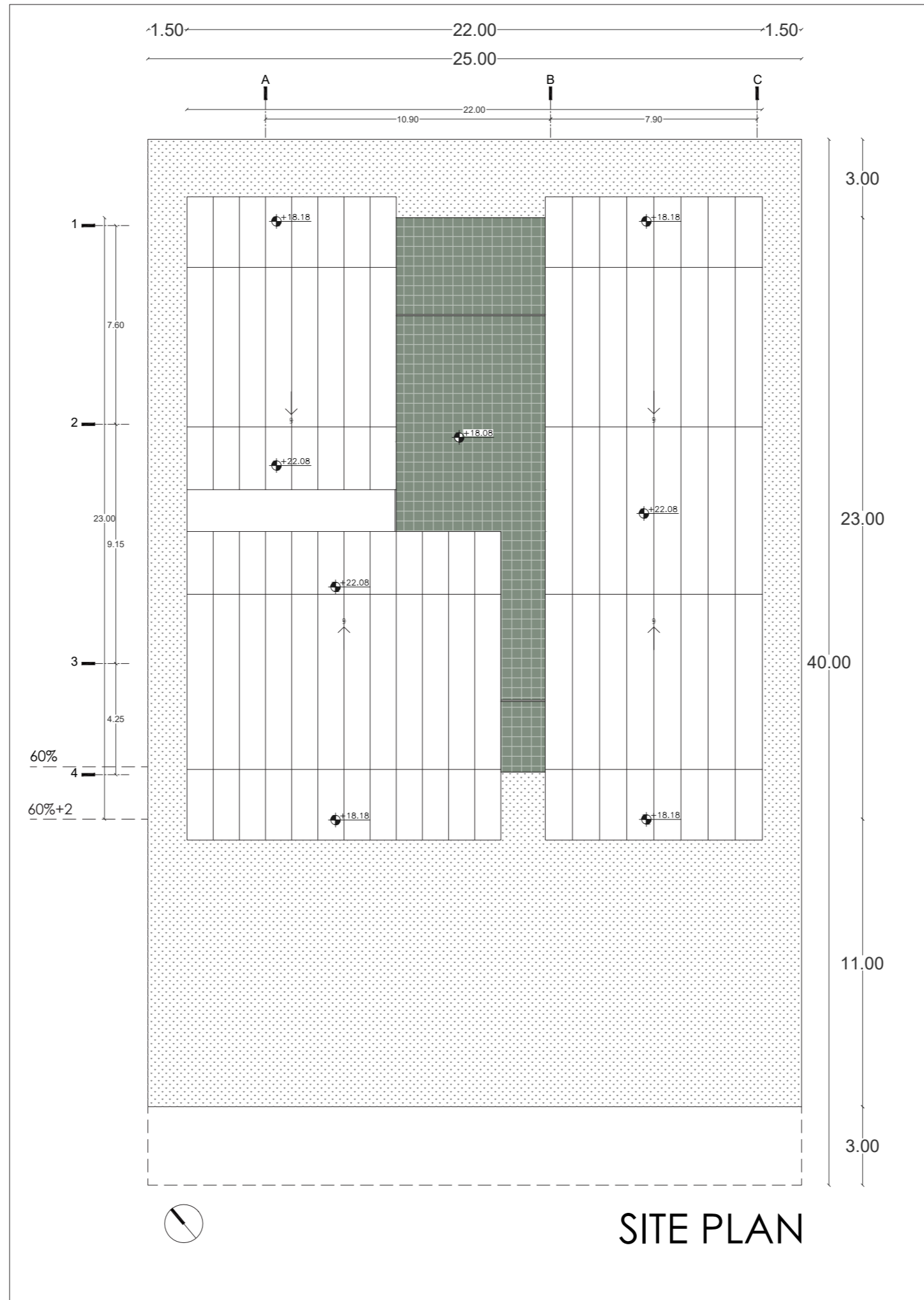

EXTERIOR VIEWS













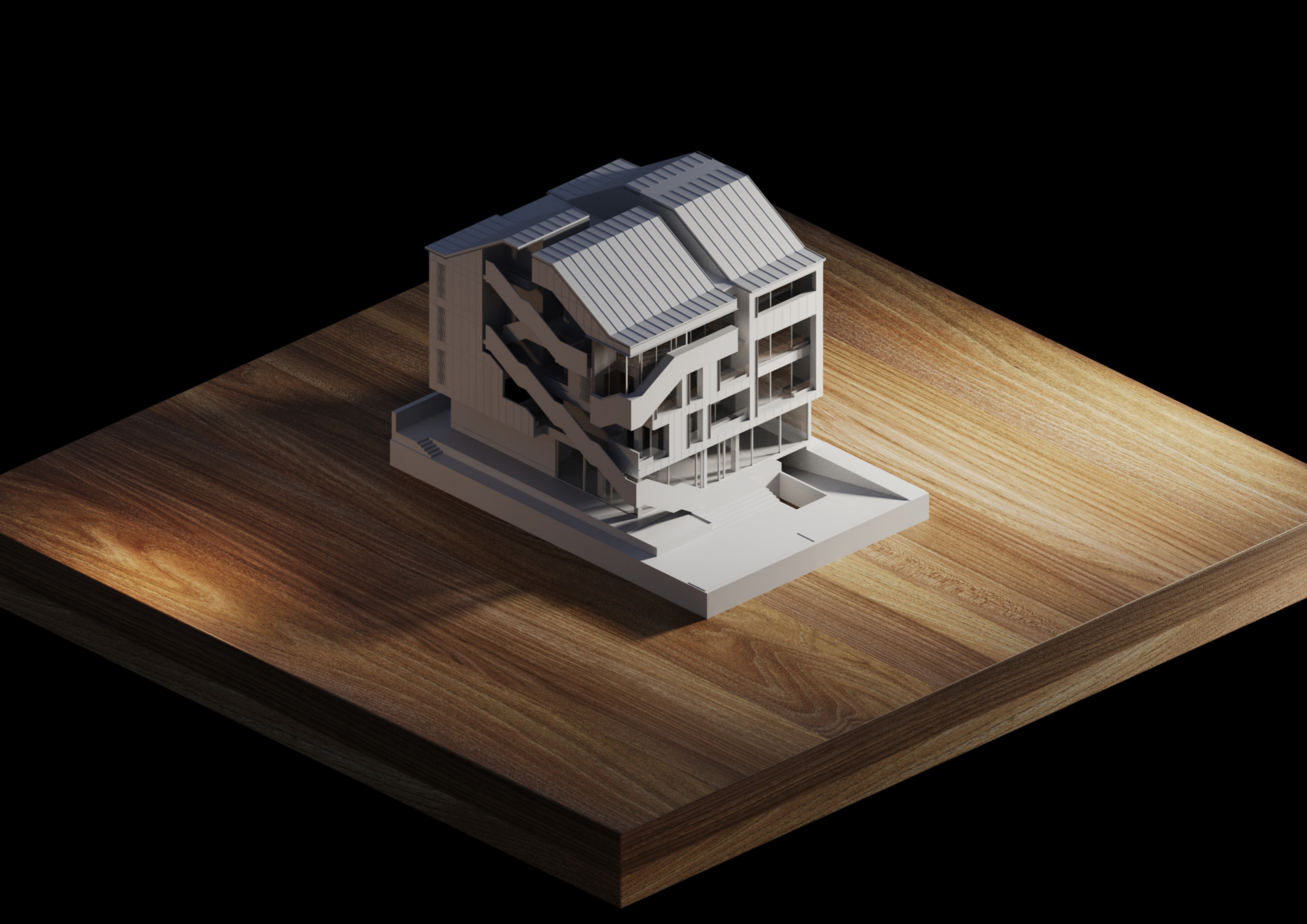



ZANDIGAN.COM